

Go to www.vtechcanada.com
for the latest VTech product news.

SN5147

Amplified
Corded/Cordless Answering System
with Big Buttons and Display



vtech[®]



User's manual
(Canada version)

Congratulations

on purchasing your new VTech product. Before using this telephone, please read **Important safety instructions**.

This manual has all the feature operations and troubleshooting necessary to install and operate your new VTech telephone. Please review this manual thoroughly to ensure proper installation and operation of this innovative and feature rich VTech product.

For support, shopping, and everything new at VTech, visit our website at www.vtechcanada.com.



Telephones identified with this logo have reduced noise and interference when used with most T-coil equipped hearing aids and cochlear implants. The TIA-1083 Compliant Logo is a trademark of the Telecommunications Industry Association. Used under license.



The ENERGY STAR® program (www.energystar.gov) recognizes and encourages the use of products that save energy and help protect our environment. We are proud to mark this product with the ENERGY STAR® label indicating it meets the latest energy efficiency guidelines.

Important safety instructions

When using your telephone equipment, basic safety precautions should always be followed to reduce the risk of fire, electric shock and injury, including the following:

1. Read and understand all instructions.
2. Follow all warnings and instructions marked on the product.
3. Unplug this product from the wall outlet before cleaning. Do not use liquid or aerosol cleaners. Use a damp cloth for cleaning.
4. Do not use this product near water such as near a bath tub, wash bowl, kitchen sink, laundry tub or a swimming pool, or in a wet basement or shower.
5. Do not place this product on an unstable table, shelf, stand or other unstable surfaces.
6. Avoid placing the telephone system in places with extreme temperature, direct sunlight, or other electrical devices. Protect your phone from moisture, dust, corrosive liquids and fumes.
7. Slots and openings in the back or bottom of the telephone base and handset are provided for ventilation. To protect them from overheating, these openings must not be blocked by placing the product on a soft surface such as a bed, sofa or rug. This product should never be placed near or over a radiator or heat register. This product should not be placed in any area where proper ventilation is not provided.
8. This product should be operated only from the type of power source indicated on the marking label. If you are not sure of the type of power supply in your home or office, consult your dealer or local power company.
9. Do not allow anything to rest on the power cord. Do not install this product where the cord may be walked on.
10. Never push objects of any kind into this product through the slots in the telephone base or handset because they may touch dangerous voltage points or create a short circuit. Never spill liquid of any kind on the product.

11. To reduce the risk of electric shock, do not disassemble this product, but take it to an authorized service facility. Opening or removing parts of the telephone base or handset other than specified access doors may expose you to dangerous voltages or other risks. Incorrect reassembling can cause electric shock when the product is subsequently used.
12. Do not overload wall outlets and extension cords.
13. Unplug this product from the wall outlet and refer servicing to an authorized service facility under the following conditions:
 - When the power supply cord or plug is damaged or frayed.
 - If liquid has been spilled onto the product.
 - If the product has been exposed to rain or water.
 - If the product does not operate normally by following the operating instructions. Adjust only those controls that are covered by the operation instructions. Improper adjustment of other controls may result in damage and often requires extensive work by an authorized technician to restore the product to normal operation.
 - If the product has been dropped and the telephone base and/or handset has been damaged.
 - If the product exhibits a distinct change in performance.
14. Avoid using a telephone (other than cordless) during an electrical storm. There is a remote risk of electric shock from lightning.
15. Do not use the telephone to report a gas leak in the vicinity of the leak. Under certain circumstances, a spark may be created when the adapter is plugged into the power outlet, or when the handset is replaced in its cradle. This is a common event associated with the closing of any electrical circuit. The user should not plug the phone into a power outlet, and should not put a charged handset into the cradle, if the phone is located in an environment containing concentrations of flammable or flame-supporting gases, unless there is adequate ventilation. A spark in such an environment could create a fire or explosion. Such environments might include: medical use of oxygen without adequate ventilation; industrial gases (cleaning solvents; gasoline vapors; etc.); a leak of natural gas; etc.
16. Only put the handset of your telephone next to your ear when it is in normal talk mode.
17. The power adapter is intended to be correctly oriented in a vertical or floor mount position. The prongs are not designed to hold the plug in place if it is plugged into a ceiling, under-the-table or cabinet outlet.
18. For pluggable equipment, the socket-outlet shall be installed near the equipment and shall be easily accessible.
19. **CAUTION:** Use only the batteries indicated in this manual. There may be a risk of explosion if a wrong type of battery is used for the handset. Use only the supplied rechargeable batteries or replacement batteries (BT205662) for the handset. Do not dispose of batteries in a fire. They may explode.
20. Use only the adapter included with this product. Incorrect adapter polarity or voltage can seriously damage the product.
Base unit power adapter: Output:
6V DC @ 800mA.
Charger power adapter: Output:
6V DC @ 400mA.

SAVE THESE INSTRUCTIONS

Battery

- Use only the batteries provided or equivalent. To order a replacement, visit our website at www.vtechcanada.com or call 1 (800) 267-7377.
- Do not dispose of the battery in a fire. Check with local waste management codes for special disposal instructions.

- Do not open or mutilate the battery. Released electrolyte is corrosive and may cause burns or injury to the eyes or skin. The electrolyte may be toxic if swallowed.
- Exercise care in handling batteries in order not to create a short circuit with conductive materials.
- Charge the battery provided with this product only in accordance with the instructions and limitations specified in this manual.

Precautions for users of implanted cardiac pacemakers

Cardiac pacemakers (applies only to digital cordless telephones):

Wireless Technology Research, LLC (WTR), an independent research entity, led a multidisciplinary evaluation of the interference between portable wireless telephones and implanted cardiac pacemakers. Supported by the U.S. Food and Drug Administration, WTR recommends to physicians that:

Pacemaker patients

- Should keep wireless telephones at least six inches from the pacemaker.
- Should NOT place wireless telephones directly over the pacemaker, such as in a breast pocket, when it is turned ON.
- Should use the wireless telephone at the ear opposite the pacemaker.

WTR's evaluation did not identify any risk to bystanders with pacemakers from other persons using wireless telephones.

About cordless telephones

- **Privacy:** The same features that make a cordless telephone convenient create some limitations. Telephone calls are transmitted between the telephone base and the cordless handset by radio waves, so there is a possibility that the cordless telephone conversations could be intercepted by radio receiving equipment within range of the cordless handset. For this reason,

you should not think of cordless telephone conversations as being as private as those on corded telephones.

- **Electrical power:** The telephone base of this cordless telephone must be connected to a working electrical outlet. The electrical outlet should not be controlled by a wall switch. Calls cannot be made from the cordless handset if the telephone base is unplugged, switched off or if the electrical power is interrupted.
- **Potential TV interference:** Some cordless telephones operate at frequencies that may cause interference to televisions and VCRs. To minimize or prevent such interference, do not place the telephone base of the cordless telephone near or on top of a TV or VCR. If interference is experienced, moving the cordless telephone farther away from the TV or VCR often reduces or eliminates the interference.
- **Rechargeable batteries:** Exercise care in handling batteries in order not to create a short circuit with conducting material such as rings, bracelets and keys. The battery or conductor may overheat and cause harm. Observe proper polarity between the battery and the battery charger.
- **Nickel-metal hydride rechargeable batteries:** Dispose of these batteries in a safe manner. Do not burn or puncture the battery. Like other batteries of this type, if burned or punctured, they could release caustic material which could cause injury.

Table of contents

What's in the box	1
Overview	2
Telephone base overview	2
Handset overview	4
Charger overview	5
Display icons overview	6
Telephone base lights overview	6
Handset lights overview	6
Connect	7
Connect the telephone base	7
Connect the charger	7
Mount the telephone base	7
Install and charge the battery	9
Line power mode (no AC power)	10
Before use	11
Set date and time	11
Voice guide to set Smart call blocker	11
Voice guide to set answering system	11
Operating range	11
Configure your telephone	12
Use the handset menu	12
LCD language	12
Use caller ID to automatically set date and time	12
SOS emergency call	12
How does SOS emergency call work? ...	13
Set SOS emergency number	13
Enable or disable internal SOS alert	14
Record SOS message	14
Play or reset SOS message	14
Ringer volume	15
Ringer tone	15
Set date and time	15
Caller ID announce	16
Set voicemail number	16
Clear voicemail indicator	16
Key tone	17
Talking digits	17
Home area code	17
Dial mode	18
Temporary tone dialing	18

Photo speed dial	18
Store a photo speed dial entry	19
Insert photos for speed dial keys	19
Dial a speed dial number	20
Alarm reminder and melody	20
Set alarm reminder	20
Turn off a reminder	21
Set reminder melody	21
Rename reminders	21
Telephone operations	22
Make a call	22
Predial a call	22
Answer a call	22
End a call	22
Make SOS emergency call	23
Photo/memory speed dial	23
Handset speakerphone	24
Volume	24
Equalizer	24
Audio Assist [®]	25
Mute	25
Join a call in progress	25
Call waiting	25
Chain dialing	26
Find handset	26
Redial list	27
Review a redial list entry	27
Dial a redial list entry	27
Delete a redial list entry	27
Intercom	27
Answer an incoming call during an intercom call	28
Call transfer using intercom	28
Phonebook	29
Add a phonebook entry	29
Review a phonebook entry	30
Alphabetical search	30
Save a redial entry to the phonebook ...	30
Delete a phonebook entry	30
Edit a phonebook entry	31
Dial a phonebook entry	31
Caller ID	31
Review a caller ID log entry	31

Memory match	32
Missed call indicator	32
Dial a caller ID log entry.....	32
Save a caller ID log entry to the phonebook	32
Delete the caller ID log entries.....	33
Smart call blocker *	33
Call categories	34
Set Smart call blocker on/off.....	35
Set welcome calls.....	35
Set unwelcome calls	39
Control calls without numbers	41
Control uncategorized calls.....	42
Screening announcements	43
Voice guide to set Smart call blocker	44
Screen calls without numbers	45
Screen uncategorized calls.....	46
Option while on a screened call.....	48
Sound settings	48
Key tone	48
Handset and base ringer tone.....	48
Handset and base ringer volume.....	49
Temporary ringer silencing	49
About the built-in answering system and voicemail service	50
Set your built-in answering system	50
Turn the answering system on or off.....	50
Default announcement	51
Record your own announcement	51
Play the announcement	51
Delete the announcement	51
Voice guide to set Answering system	52
Set number of rings	52
Set recording time	52
Turn the call screening on or off.....	53
Turn the message alert tone on or off ...	53
Use your built-in answering system	53
New message indication	53
Message playback	54
Delete all messages	55
Call screening	55
Call intercept.....	55
Record, play or delete memos.....	56

Use the built-in answering system and voicemail service	56
Retrieve voicemail from telephone service.....	57
Retrieve voicemail.....	57
Set your voicemail number.....	57
Turn off the new voicemail indicators.....	57
Remote access.....	58
Access your answering system remotely.....	58
Set your remote access code	58
Expand your telephone system.....	59
Add and register expansion handset	59
Add and register photo speed dial handset	59
Device setup.....	60
Add and register a new device	60
Audio doorbell	62
Set chime volume	62
Set chime tone.....	62
Answer, decline or record a doorbell call	62
Divert doorbell calls	63
Test device signal strength	65
Test Extension ringer's signal strength ...	65
Test Audio doorbell's signal strength	65
Test SOS pendant's signal strength.....	66
Device monitoring.....	66
View device status	66
View device log	66
Rename a device.....	67
Screen messages.....	67
General product care.....	70
Storage.....	70
Frequently asked questions.....	70
The RBRC® seal	74
FCC, ACTA and IC regulations	75
Limited warranty.....	77
Technical specifications	79

What's in the box

Your telephone package contains the following items. Save your sales receipt and original packaging in the event warranty service is necessary.

NOTE

- To purchase a replacement battery or power adapter, visit our website at www.vtechcanada.com or call **1 (800) 267-7377**.

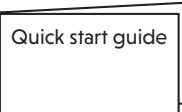
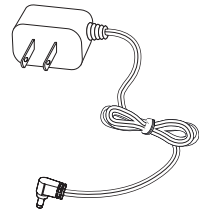
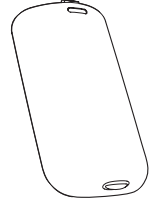
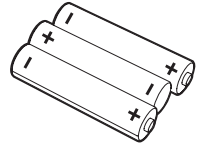
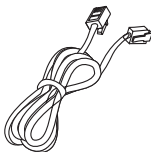
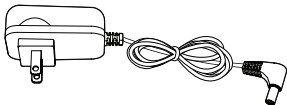
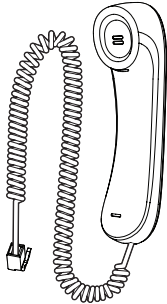
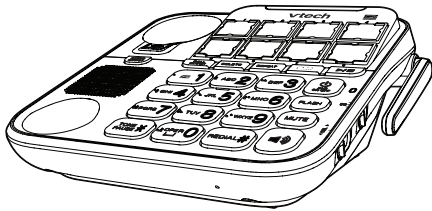

Overview

Telephone base overview

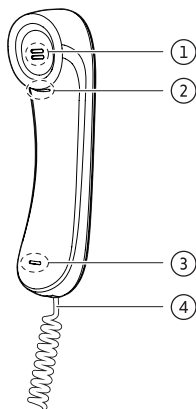

1 – Handset earpiece

2 – Slot for handset tab

- For optional wall mounting.

3 – Handset speaker

4 – Coiled handset cord

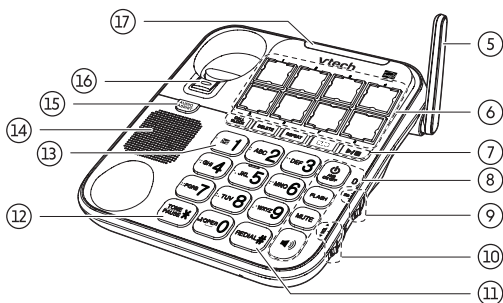

5 – Antenna

6 – Photo speed dial keys

- Press to dial the preset numbers.

7 – CALL BLOCK

- Press to block the incoming call when the telephone is ringing or during the call.

DELETE

- Delete the playing message.
- Press twice to delete all old messages.

REPEAT

- Repeat a message.
- Press twice to play the previous message.

SLOW

- Press to slow down the message playback.



- Play messages.
- Stop playing messages.



8 –

- Turn on or off the answering system.
- The light turns on when the answering system is on.
- The light turns off when the answering system is off.

FLASH

- During a call, press to answer an incoming call when you receive a call waiting alert

MUTE

- Mute the microphone during a call.
- Silence the base ringer temporarily while the phone is ringing.



- Press to make or answer a call using the speakerphone.

9 – EQ

- Change the quality of the handset audio to best suit your hearing.

10 – ◀ VOL ▶

- Adjust the listening volume during message playback.
- Adjust the base ringer volume while idle.

11 – REDIAL

- Press to redial the last number.

12 – TONE PAUSE *

- Switch to tone dialing temporarily during a call.
- Insert a dialing pause while dialing.

13 – [Envelope] 1

- Dial your voicemail number.

14 – Speaker

15 – AUDIO ASSIST

AUDIO ASSIST®

- Enhance the clarity and loudness of your caller's voice on the corded handset earpiece when you are on a call.

16 – Handset tab

- For optional wall mounting.

17 – Visual ringer indicator

- On when the telephone is in use, or when the answering system is answering an incoming call.
- On when a handset is being registered.
- Flashes when the telephone base is ringing.

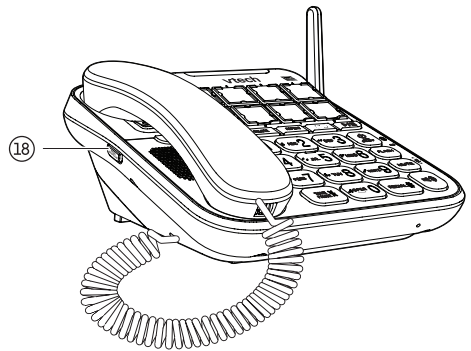

18 – PAGE / INTERCOM

- While the telephone is idle, press to make an intercom call to all registered devices.

Handset overview

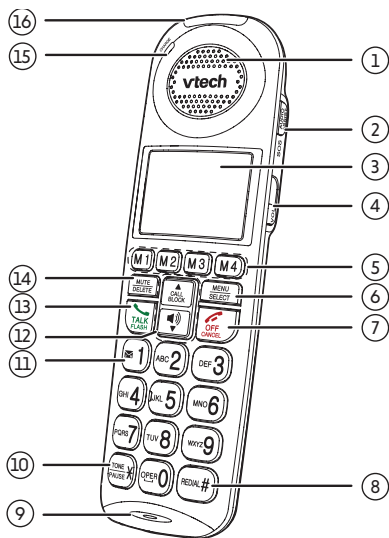

1 – Handset earpiece

2 – AUDIO ASSIST / SOS

- Press to enhance the clarity and loudness of your caller's voice on the cordless handset earpiece when you are on a call, or listening to a message or an announcement.
- Press and hold to page all registered devices and call the preset SOS numbers when the handset is not in use.

3 – LCD display

4 – VOL

- Slide to adjust the listening volume during a call or message playback.
- Slide to adjust the handset volume while idle.

5 – M1

- Press to call the preset speed dial memory number 1.

M 2

- Press to call the preset speed dial memory number 2.

M 3

- Press to call the preset speed dial memory number 3.

M 4

- Press to call the preset speed dial memory number 4.

6 – MENU SELECT

- Show the menu.
- While in a menu, press to select an item, or save an entry or setting.

7 – OFF CANCEL

- Hang up a call.
- Return to the previous menu or idle mode without making changes.
- Delete digits while predialing.
- Silence the handset ringer temporarily while the phone is ringing.
- Press and hold to erase the missed call indicator while the handset is not in use.

8 – REDIAL

- Press and hold to review the redial list.

9 – Microphone

10 – TONE PAUSE X

- Switch to tone dialing temporarily during a call if you have pulse service.
- While entering numbers, press and hold to insert a dialing pause.



- 11 –**
- Set or dial your voicemail number.

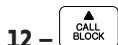

- 12 –**
- Scroll up while in a menu, or in the phonebook, caller ID log or redial list.
 - Move the cursor to the left when entering numbers or names.
 - Press to show the Call block menu.
 - Press to block the incoming call when the telephone is ringing or during the call.



- 13 –**
- Scroll down while in a menu, or in the phonebook, caller ID log or redial list.
 - Move the cursor to the right when entering numbers or names.
 - Press to make or answer a call using the speakerphone.
 - Switch between the handset speakerphone and the handset earpiece during a call.



- 13 –**
- Press to make or answer a call.
 - During a call, press to answer an incoming call when you receive a call waiting alert.
 - During message playback, press to call back the caller if the caller's number is available.



- 14 –**
- Mute the microphone during a call.
 - Silence the handset ringer temporarily while the phone is ringing.
 - Delete the displayed entry while reviewing the phonebook, caller ID log or redial list.

- Delete digits or characters when entering numbers or names.

15 – CHARGE light

- On when the handset is charging.

16 – Visual ringer indicator

- Flashes when the handset is ringing.

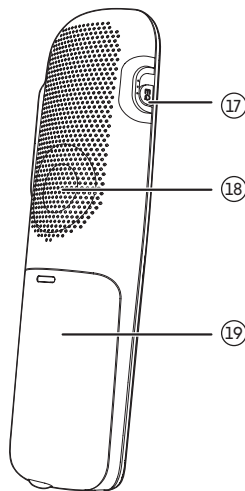

- 17 –**
- Change the quality of the handset audio to best suit your hearing.

18 – Speaker





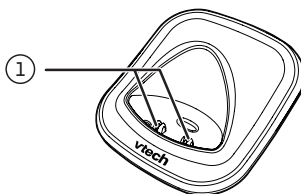

19 – Battery compartment cover

Charger overview



1 – Charging pole

Display icons overview

	The battery icon flashes when the battery is low and needs charging.
	The battery icon animates when the battery is charging.
	The battery icon becomes solid when the battery is fully charged.
	The handset speakerphone is in use.
	The handset ringer is turned off.
	There are new voicemail received from your telephone service provider.
MUTE	The handset microphone is muted.
NEW	There are new caller ID log entries.
ANS ON	The answering system is turned on.
	There are new messages in the answering system.
	The number of new/old messages recorded.
AUDIO ASSIST	The handset Audio Assist feature is on.

Telephone base lights overview

Visual ringer indicator	<ul style="list-style-type: none"> Flashes when the telephone base is ringing. On when the telephone is in use, or when the answering system is answering an incoming call. On when you are registering a handset or device.
	On when the answering system is turned on.

Handset lights overview

Visual ringer indicator	Flashes when the handset is ringing.
CHARGE light	On when the handset is charging in the charger.

Connect

You can choose to connect the telephone base for desktop usage or wall mounting.

NOTES

- Use only the adapters provided.
- Make sure the telephone is not connected to the switch controlled electric outlet.
- The adapter's prongs are not designed to hold the weight of the telephone. Make sure you connect the adapter to a wall outlet that is in vertical or floor mount position. Do not connect it to undermount and ceiling outlet. Otherwise, your telephone would fall out of the outlet.

TIP

- If you subscribe to digital subscriber line (DSL) high-speed Internet service through your telephone line, make sure you install a **DSL filter** (not included) between the telephone line cord and telephone wall jack. Contact your DSL service provider for more information.

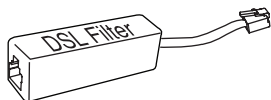

Connect the telephone base

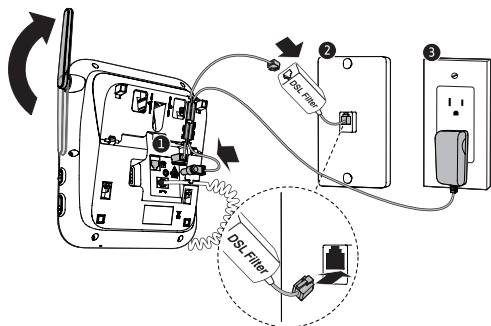

Connect the charger

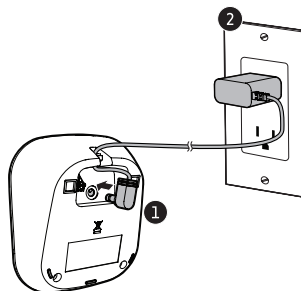

Mount the telephone base

1. Pull the integrated wall mount bracket and release it from the tabletop orientation.

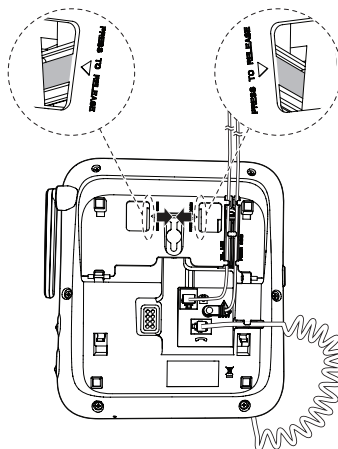

2. Rotate it down into wall mount position and then push it into the telephone base until it clicks into place.

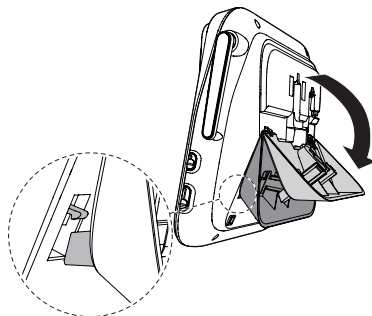

- Slide the handset tab upward. Rotate the handset tab by 180 degrees. The protruding edge of the handset tab holds the corded handset in place when the telephone is mounted on the wall.

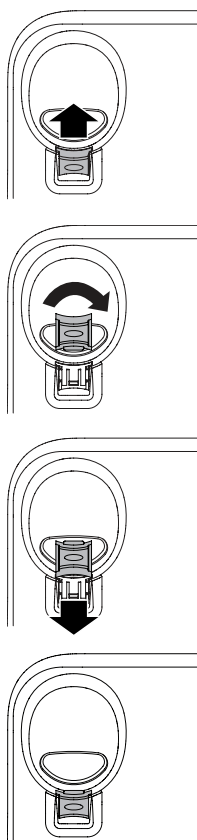

- Align the mounting studs on the mounting plate with the mounting holes on the bracket and press the telephone base down until it clicks securely into place.

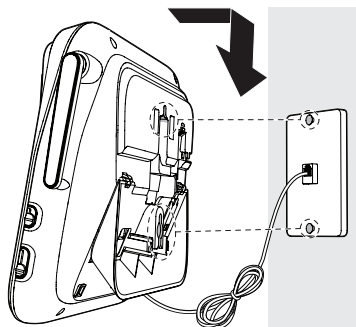

- Then, connect the power adapter.

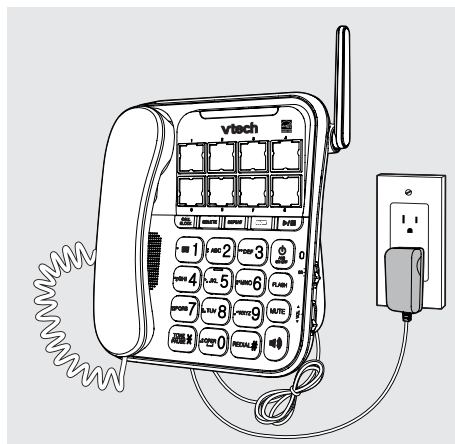

Install and charge the battery

Install the battery

Install the battery as shown below.

⚠ CAUTIONS

- Use only the rechargeable batteries provided or replacement batteries (model BT205662).
- Do not use other alkaline, manganese or Ni-Cd batteries, nor other non-rechargeable batteries for operating the cordless handset. They may cause failure or malfunction of the handset or the telephone system.

📄 NOTES

- Charge the batteries provided with this product only in accordance with the instructions and limitations specified in this manual.
- If the handset will not be used for a long time, disconnect and remove the batteries to prevent possible leakage.

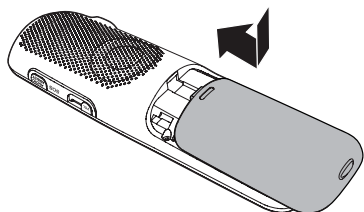
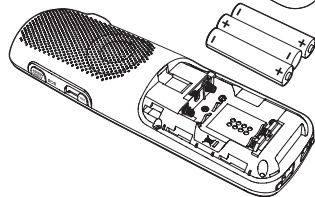
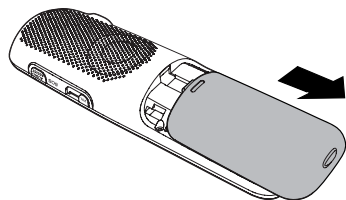

Charge the handset battery

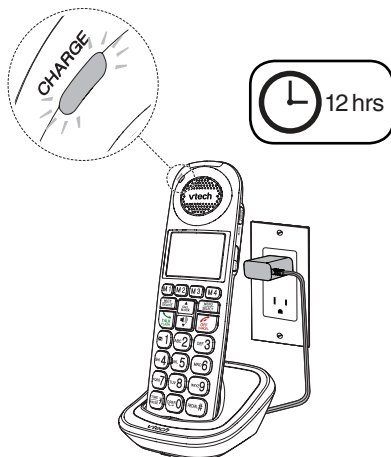

Place the handset in the charger to charge.



Once you have installed the battery, the handset LCD display indicates the battery status (see the table on the next page).

📄 NOTES

- Press **CANCEL** on the handset or place the handset in the charger will bypass the set date and time.
- For best performance, keep the handset in the charger when not in use.
- The battery is fully charged after 12 hours of continuous charging.

BATTERY INDICATORS	BATTERY STATUS	ACTION
The screen is blank, or displays Place in charger and  flashes.	The battery has no or very little charge. The handset cannot be used.	Charge without interruption (at least 30 minutes).
The screen displays Low battery and  flashes.	The battery has enough charge to be used for a short time.	Charge without interruption (about 30 minutes).
The screen displays HANDSET .	The battery is charged.	To keep the battery charged, place it in the charger when not in use.

When the battery is fully charged, you can expect the following performance:

OPERATION	OPERATING TIME
While in use (talking*)	Up to 7 hours
While in speakerphone mode (talking*)	Up to 3.5 hours
While not in use (standby**)	Up to 5 days

* Operating times vary depending on your actual use and the age of the battery.

** Handset is not charging nor in use.

Line power mode (no AC power)

This telephone provides minimal functionality during a power failure. When AC power is not available, the cordless handset screen is blank and many telephone features do not function. Only touch-tone dialing and corded handset volume adjustment are supported. The telephone uses power from the telephone line to enable you to make and answer calls using the corded handset and dialing keys.

To make a call during a power failure

1. Lift the corded handset and wait for a dial tone.
2. Slowly dial a telephone number using the dialing keys. Wait to hear each key tone upon inputting a digit before pressing the next dialing key.

To answer a call during a power failure

- Lift the corded handset.

Before use

After you install your telephone or power returns following a power outage, the cordless handset will prompt you to set the date and time.

Set date and time

NOTE

- Make sure you set the date and time including the year correctly; otherwise the answering system does not announce the correct day of the week for your recorded messages time stamp.
1. Use the dialing keys (**0-9**) to enter the month (**MM**), date (**DD**) and year (**YY**). Then press **SELECT**.
 2. Use the dialing keys (**0-9**) to enter the hour (**HH**) and minute (**MM**). Then press any dialing keys (**0-9, * or #**) to choose between **AM** and **PM**.
 3. Press **SELECT** to save.

Voice guide to set Smart call blocker

After the date and time setting is done or skipped, the cordless handset then prompts if you want to set Smart call blocker. Press **SELECT** to start the Smart call blocker setup via voice guide. For more details, see **Voice guide to set Smart call blocker** on page 44. To skip the setup, press **CANCEL** on the cordless handset.

Voice guide to set answering system

After the Smart call blocker setting is done or skipped, the cordless handset will then prompt if you want to set up the answering system. Press **SELECT** to start the answering system setup via voice guide. For more details, see **Voice guide to set Answering system** on page 52. To skip the setup, press **CANCEL** on the cordless handset.

Check for dial tone

Press **TALK**. If you hear a dial tone, the installation is successful.

If you do not hear a dial tone:

- Make sure the installation procedures described above are properly done.
- It may be a wiring problem. If you have changed your telephone service to digital service from a cable company or a VoIP service provider, the telephone line may need to be rewired to allow all existing telephone jacks to work. Contact your cable/VoIP service provider for more information.

Operating range

This telephone operates with the maximum power allowed by the Federal Communications Commission (FCC). Even so, this cordless handset and telephone base can communicate over a certain distance - which can vary with the locations of the telephone base and handset, the weather, and the layout of your home or office.

When the cordless handset is out of range, the handset displays **Out of range OR no pwr at base**.

If there is a call while the cordless handset is out of range, it may not ring, or if it does ring, the call may not connect well when you press **TALK**. Move closer to the telephone base, then press **TALK** to answer the call.

If the cordless handset moves out of range during a telephone conversation, there may be interference. To improve reception, move closer to the telephone base.

Configure your telephone

Use the handset menu

1. Press **MENU** on the cordless handset in idle mode to enter the main menu.
2. Press **▼** or **▲** until the screen displays the desired feature menu.
3. Press **SELECT**.
 - To return to the previous menu, press **CANCEL**.
 - To return to idle mode, press and hold CANCEL.

LCD language

The LCD language is preset to English. You can select English, French or Spanish to be used in all screen displays.

1. Press **MENU** on the cordless handset in idle mode to enter the main menu.
2. Press **▼** or **▲** to choose **Settings** and then press **SELECT** twice.
3. Press **▼** or **▲** to choose **English**, **Français** or **Español**.
4. Press **SELECT** twice to save your setting. You hear a confirmation tone.

Use caller ID to automatically set date and time

If you subscribe to caller ID service, you can choose to set the date and time for each incoming call by the caller ID information automatically. The default setting is **On**.

1. Press **MENU** on the cordless handset in idle mode to enter the main menu.
2. Press **▼** or **▲** to choose **Settings** and then press **SELECT**.
3. Press **▼** or **▲** to choose **CID time sync** and then press **SELECT**.
4. Press **▼** or **▲** to choose **On** or **Off**.
5. Press **SELECT** to save. You hear a confirmation tone.

SOS emergency call

The **AUDIO ASSIST/SOS** button on the cordless handset can function as SOS emergency button. It lets you quickly page other system devices and call preset external numbers for help in an emergency.

You can preset up to five SOS numbers.

If you have purchased and registered a Wearable home SOS pendant (**SN7022**) to your telephone system, the SOS pendant will function as same as the SOS emergency button of the cordless handset.

⚠ CAUTIONS

- To ensure proper operation, the telephone system must be installed according to the installation instructions on page 7 to page 9. To verify that the telephone system is operating properly and can successfully make emergency calls to the preset numbers, the telephone system must be tested immediately after installation, and periodically thereafter, according to the setup instructions on page 13 to page 14, and the operations on page 23.
- The telephone system cannot make an emergency call when other equipment (telephone, answering system, computer modem, etc.) connected to the same phone line is in use.
- Do not solely rely on the SOS button on the cordless handset, or the Wearable home SOS pendant (**SN7022**, purchased separately), for getting help in case of emergency. The functionality of the SOS emergency call is dependent on the phone settings and network availability.

📄 NOTE

- We recommend you set all the five SOS numbers to maximize the possibility of receiving response from others when you make an emergency call.

How does SOS emergency call work?

- To make an emergency call, press and hold **AUDIO ASSIST/SOS** on the right side of the cordless handset for three seconds. The telephone base announces "*Emergency mode is activated*". The handset then pages all system devices. All devices ring an alert tone and the handset screen shows **SOS mode** for 20 seconds. After that, the telephone then calls the preset SOS numbers in sequence until the call is answered.
 - The telephone enables internal SOS alert by default. When this feature is enabled, the telephone pages all system devices before calling the preset SOS numbers.
 - If you disable internal SOS alert (see page 14), the telephone calls the preset SOS numbers directly when you press and hold **AUDIO ASSIST/SOS** on the cordless handset.
- When the SOS call to the preset external number is answered, the call receiver hears an SOS message. You can record your own message or use the default message (see page 14).
- The SOS message played by the telephone asks the SOS call receiver to respond by pressing a number key. After the call receiver presses a number key, you can then talk to the call receiver.
- When the SOS emergency call is answered by answering machine or voicemail, the call will be terminated after 60 seconds. The telephone then dials the next SOS number in sequence.

- When none of the preset SOS numbers answer, the telephone re-calls the preset SOS numbers in sequence until the call is answered. The telephone will call all the preset SOS numbers for 3 times before aborting the operation when none of the calls are answered.

Set SOS emergency number

1. Press **MENU** on the cordless handset in idle mode to enter the main menu.
2. Press **▼** or **▲** to choose **Set SOS**, and then press **SELECT**.
3. Press **▼** or **▲** to choose **SOS number**, and then press **SELECT**.
4. Scroll to select **SOS 1**, **SOS 2**, **SOS 3**, **SOS 4**, or **SOS 5**, and then press **SELECT**.
5. Press **SELECT** again, and then enter the emergency number and name.
6. Press **SELECT** to save your setting. You hear a confirmation tone.

While entering names and numbers, you can:

- Press **DELETE** to backspace and erase a digit or character.
- Press and hold **DELETE** to erase the entire entry.
- Press **▼** or **▲** to move the cursor to the left or right.
- Press and hold **PAUSE** to insert a dialing pause (for entering numbers only).
- Press **0** to add a space (for entering names only).

Enable or disable internal SOS alert

Internal SOS alert is enabled by default.

When you press and hold the **AUDIO ASSIST/SOS** button to make an emergency call, the telephone pages all registered system devices for 20 seconds. After that, the telephone then calls the five preset SOS numbers in sequence, until the call is answered.

You can disable this setting to allow you to make emergency calls directly to the preset SOS numbers.

1. Press **MENU** on the cordless handset in idle mode to enter the main menu.
2. Press ▼ or ▲ to choose **Set SOS**, and then press **SELECT**.
3. Press **SELECT** to choose **Call internal**.
4. Press ▼ or ▲ to choose **Enable** or **Disable**, and then press **SELECT**.

Record SOS message

The SOS message is played to the call receiver when you press and hold the **AUDIO ASSIST/SOS** button on the cordless handset to make an emergency call.

The default SOS message is *"This is an emergency call. Please press any number key to start the conversation."* You can record your own message using the cordless handset.

1. Press **MENU** on the cordless handset in idle mode to enter the main menu.
2. Press ▼ or ▲ to choose **Set SOS**, and then press **SELECT**.
3. Press ▼ or ▲ to choose **SOS message**, and then press **SELECT**.
4. Press **SELECT** again to choose **Record annc**, and then press **SELECT**. The handset announces, *"Record after the tone. Press STOP when you are done."*

5. Speak towards the handset microphone. Press **5** when you finish recording. The handset announces *"Recorded."*

Play or reset SOS message

1. Press **MENU** on the cordless handset in idle mode to enter the main menu.
2. Press ▼ or ▲ to choose **Set SOS**, and then press **SELECT**.
3. Press ▼ or ▲ to choose **SOS message**, and then press **SELECT**.
4. Scroll to select **Play annc** or **Reset annc**, and then press **SELECT**.
5. If you choose **Reset annc**, press **SELECT** again to confirm using the default SOS message.

TIP

- Make sure your recorded SOS message includes your name, your SOS message, and a request to the far-end caller on pressing any number key to start the conversation.

Ringer volume

You can set the ringer volume level of the cordless handset and telephone base to one of five levels or turn the ringer off.

1. Press **MENU** on the cordless handset in idle mode to enter the main menu.
2. Press ▼ or ▲ to scroll to **Ringers**, then press **SELECT**.
3. Press ▼ or ▲ to choose **Handset** or **Base**, then press **SELECT**.
4. Press **SELECT** again to select **Ringer volume**.
5. Press ▼ or ▲ to sample each volume level.
6. Press **SELECT** to save your preference.

⚠ CAUTION

- For hearing protection, do not put the cordless handset near your ear when the telephone is ringing. Loud ringer sound may damage your hearing. Adjust the volume to lower the ringer sound if you find it too loud.



Ringer tone

You can choose one of ten ringer tones for the cordless handset or telephone base.

1. Press **MENU** on the cordless handset in idle mode to enter the main menu.
2. Press ▼ or ▲ to scroll to **Ringers**, then press **SELECT**.
3. Press ▼ or ▲ to choose **Handset** or **Base**, then press **SELECT**.
4. Press ▼ or ▲ to scroll to **Ringer tone**, then press **SELECT**.
5. Press ▼ or ▲ to sample each ringer tone.
6. Press **SELECT** to save your preference.

Set date and time

📄 NOTE

- Make sure you set the date and time including the year correctly; otherwise the answering system does not announce the correct day of the week for your recorded messages time stamp.
1. Press **MENU** on the cordless handset in idle mode to enter the main menu.
 2. Press ▼ or ▲ to choose **Set date/time** and then press **SELECT**.
 3. Use the dialing keys (**0-9**) to enter the month (**MM**), date (**DD**) and year (**YY**). Then press **SELECT**.
 4. Use the dialing keys (**0-9**) to enter the hour (**HH**) and minute (**MM**). Then press any dialing keys (**0-9**, * or #) to toggle between **AM** and **PM**.
 5. Press **SELECT** to save your setting. You hear a confirmation tone.

Caller ID announce

The caller ID announce feature lets you know who's calling without having to look at the display. When you have an incoming call, the handset and/or the telephone base speaks "Call from..." and the name of the caller based on the phonebook or caller ID information. If the caller's name is private or unknown, the phone number up to the last 11 digits will be announced. If the caller's phone number is also private or unknown, no information will be announced.

1. Press **MENU** on the cordless handset in idle mode to enter the main menu.
2. Press ▼ or ▲ to choose **Caller ID annnc** and then press **SELECT**.
3. Press ▼ or ▲ to choose **On** or **Off**, and then press **SELECT** to save your setting. You hear a confirmation tone.

NOTES

- To use the caller ID announce feature, you must subscribe to caller ID service from your telephone service provider.
- This feature does not announce information for call waiting calls.
- It takes at least 2 rings for the phone to receive caller ID information and announce it. If the phone is answered before the end of the second ring, the phone won't have time to announce the caller's information.
- Pronunciation of names may vary with this feature. Not all names may be pronounced correctly.
- Caller ID announce is available in English only.

Set voicemail number

If you subscribe to a voicemail service offered by your **telephone service provider**, you can save your voicemail number to  **1** for quick access. The voicemail number is shared by all devices.

To retrieve voicemail from your service provider:

1. Press and hold 1 when the cordless handset is not in use.
2. Enter the voicemail access number provided by your telephone service provider (up to 30 digits) when prompted.
3. Press **SELECT** on the handset.

Clear voicemail indicator

Use this feature when the telephone indicates that there is new voicemail but there are none. This feature only turns off the indicators, **New voicemail** and . It does not delete your voicemail messages. As long as you have new voicemail messages, your telephone service provider continues to send the signal to turn on the indicators.

1. Press **MENU** on the cordless handset in idle mode to enter the main menu.
2. Scroll to **Settings**, then press **SELECT** on the cordless handset.
3. Scroll to **Clr voicemail**, then press **SELECT** on the cordless handset. The screen shows **Reset Voicemail Indicator?**.
4. Press **SELECT** on the cordless handset.

Key tone

The cordless handset is set to beep with each key press. You can adjust the key tone volume or turn it off. If you turn off the key tone, there are no beeps when you press keys.

1. Press **MENU** on the cordless handset in idle mode to enter the main menu.
2. Press ▼ or ▲ to choose **Settings** and then press **SELECT**.
3. Press ▼ or ▲ to scroll to **Key tone**, then press **SELECT**.
4. Press ▼ or ▲ to select the desired volume or **Off**.
5. Press **SELECT** to save your preference.

Talking digits

You can choose whether the digits are to be announced whenever you press the number keys.

1. Press **MENU** on the cordless handset in idle mode to enter the main menu.
2. Press ▼ or ▲ to choose **Talking digits** and then press **SELECT**.
3. Press ▼ or ▲ to choose **On** or **Off**.
4. Press **SELECT** to save. You hear a confirmation tone.

Home area code

You can program your home area code so that when you receive or dial a call within your local area, only seven digits are shown or dialed, and the telephone number is automatically stored without the area code in the caller ID log.

1. Press **MENU** on the cordless handset in idle mode to enter the main menu.
2. Press ▼ or ▲ to choose **Settings** and then press **SELECT**.
3. Press ▼ or ▲ to choose **Home area code**, and then press **SELECT**. The screen displays **Only for 7digit dial from CID**.
4. Use the dialing keys (**0-9**) to enter the desired home area code.
 - Press **DELETE** to delete a digit.
 - Press and hold **DELETE** to delete all digits.
5. Press **SELECT** to confirm. You hear a confirmation tone.

NOTE

- If, in the future, your telephone service provider requires you to dial the area code when making a local call, or, if you move to a location that requires it, delete the home area code you have already programmed following the steps above. After you have deleted the home area code, ___ appears.

Dial mode

The dial mode is preset to touch-tone dialing. If you have pulse (rotary) service, you need to change the dial mode to pulse dialing before using the telephone.

1. Press **MENU** on the cordless handset in idle mode to enter the main menu.
2. Press ▼ or ▲ to choose **Settings**, and then press **SELECT**.
3. Press ▼ or ▲ to choose **Dial mode**, then press **SELECT**.
4. Press ▼ or ▲ to choose **Touch-tone** or **Pulse**, then press **SELECT** to confirm your selection. You hear a confirmation tone.

Temporary tone dialing

If you have pulse (rotary) service only, you can switch from pulse to touch-tone dialing temporarily during a call. This is useful if you need to send touch-tone signals to access your telephone banking or long distance services.

1. During a call, press **TONE***.
2. Use the dialing keys to enter the number. The telephone sends touch-tone signals. It automatically returns to pulse dialing mode after you end the call.

Photo speed dial

There are eight photo speed dial direct memory keys **1** to **8** on the telephone base, and four direct memory keys **M1** to **M4** on the cordless handset.

You can store the telephone numbers you wish to quick dial to the photo speed dial keys. When you set the first four photo speed dial keys **1**, **2**, **3** and **4** on the telephone base, the same numbers will also automatically set in the **M1**, **M2**, **M3** and **M4** keys on the cordless handset.

✦ TIP

- We recommend you store at least two contacts that you may need to call them more often or immediately to photo speed keys **1** and **2**.

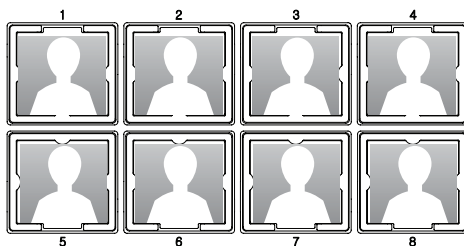

Store a photo speed dial entry

1. Press **MENU** on the cordless handset in idle mode to enter the main menu.
2. Press **▼** or **▲** to scroll to **Direct memory**, then press **SELECT**.
3. Press **▼** or **▲** to scroll to **M1, M2, M3, M4, M5, M6, M7** or **M8**, and then press **SELECT** twice.
4. When the handset display **NUMBER:**, use the dialing keys to enter the number (up to 30 digits).
5. Press **SELECT** to move on to enter the name. The handset displays **NAME:**.
6. Use the dialing keys to enter the name (up to 15 characters). Additional key presses show other characters of that particular key. The first character of every word is capitalized.
7. Press **SELECT** to save. You hear a confirmation tone.

While entering names and numbers, you can:

- Press **DELETE** to backspace and erase a digit or character.
- Press and hold **DELETE** to erase the entire entry.
- Press **▼** or **▲** to move the cursor to the left or right.
- Press and hold **PAUSE** to insert a dialing pause (for entering numbers only).
- Press **0** to add a space (for entering names only).

Insert photos for speed dial keys

You can insert photos into the photo speed dial compartments on the telephone base, or write the contact names on cards and insert them into the compartments.

NOTE

- The telephone base is shipped with protective stickers covering the photo speed dial compartments. Remove the protective sticker before use.
1. Remove the photo speed dial compartment cover.
 2. Crop your desired photo into the size specified below, and then insert it into the photo speed dial compartment. Then, insert the photo speed dial compartment cover back to the compartment.

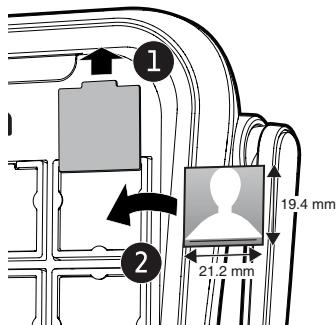

Dial a speed dial number

Using the telephone base:

1. Lift the corded handset.
2. Press one of the photo speed dial keys on the telephone base to dial the corresponding speed dial number.

-OR-

- Press , and then press one of the photo speed dial keys on the telephone base to dial the corresponding speed dial number.

Using a cordless handset:

- Press **M1**, **M2**, **M3**, or **M4** to dial the corresponding speed dial number.

-OR-

- Press , and then press **M1**, **M2**, **M3**, or **M4** to dial the corresponding speed dial number.

Alarm reminder and melody

The reminder feature helps remind you of important events. You can set alarm reminders that remind you at specific times, once, daily, or at weekdays or weekends.

Once you set a reminder, the telephone system will alarm you at the set time. You can choose different melodies for the reminder alarms.

Set alarm reminder

1. Press **MENU** on the cordless handset in idle mode to enter the main menu.
2. Press **▼** or **▲** to scroll to **Reminder** and then press **SELECT**.
3. Press **▼** or **▲** to scroll through and select from **Reminder 1** to **Reminder 10**, then press **SELECT**.
4. Press **SELECT** to select **On/Off**.
5. Press **SELECT** again to select **On**.
6. Use the dialing keys (**0-9**) to enter the hour (**HH**) and minute (**MM**).
7. Press any dialing keys (**0-9**, ***** or **#**) to toggle between **AM** and **PM**, then press **SELECT**.
8. Press **▼** or **▲** to select **Once**, **Daily**, **Mon. to Fri.**, or **Sat. to Sun.**, then press **SELECT**.

NOTES

- A reminder you have previously set up is added with an asterisk (*) after the name, for example, **Reminder 1 ***.
- When the set reminder alarm time is due, the alarm will not ring if the telephone is in use.
- The cordless handset rings for 30 seconds when the alarm time is due.
- Press any key on the handset to stop the alarm when ringing.

Turn off a reminder

1. Press **MENU** on the cordless handset in idle mode to enter the main menu.
2. Press ▼ or ▲ to choose **Reminder** and then press **SELECT**.
3. A reminder you have previously set up is added with an asterisk (*) after the name, for example, **Reminder 1 ***. Press ▼ or ▲ to scroll to your desired reminder, and then press **SELECT** to choose.
4. Press **SELECT** again to choose **On/Off**.
5. Press **SELECT** again to choose **Off**.

Set reminder melody

You can select the alarm reminder melody.

1. Press **MENU** on the cordless handset in idle mode to enter the main menu.
2. Press ▼ or ▲ to scroll to **Reminder** and then press **SELECT**.
3. A reminder you have previously set up is added with an asterisk (*) after the name, for example, **Reminder 1 ***. Press ▼ or ▲ to scroll to your desired reminder, and then press **SELECT** to choose.
4. Press ▼ or ▲ to scroll to **Melody** and then press **SELECT**.
5. Press ▼ or ▲ to scroll through and select from **Tone 1** to **Tone 10**, then press **SELECT**.

Rename reminders

You can rename the reminders to give them names that are meaningful to you.

1. Press **MENU** on the cordless handset in idle mode to enter the main menu.
2. Press ▼ or ▲ to scroll to **Reminder** and then press **SELECT**.
3. Press ▼ or ▲ to select the desired reminder you have set previously, and then press **SELECT**.
4. Press ▼ or ▲ to scroll to **Rename** and then press **SELECT**.
5. Use the dialing keys to enter the new name, and then press **SELECT** to save. You hear a confirmation tone.

While entering names, you can:

- Press **DELETE** to backspace and erase a digit or character.
- Press and hold **DELETE** to erase the entire entry.
- Press ▼ or ▲ to move the cursor to the left or right.
- Press **0** to add a space.

Telephone operations

Telephone base control key panel:

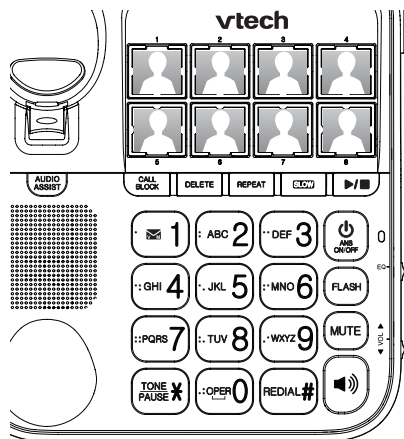

Handset control key panel:

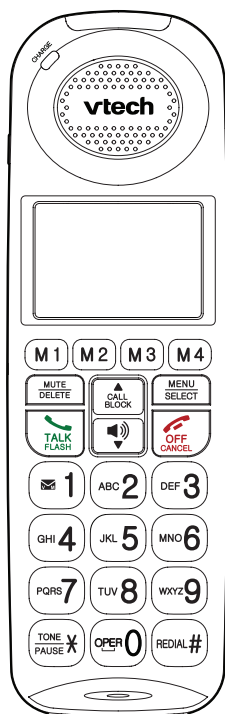

Make a call

Using a cordless handset:

- Press **TALK** or , and then dial the telephone number.

NOTES

- The screen shows the elapsed time as you talk (in hours, minutes and seconds).
- While entering numbers, press and hold PAUSE to insert a dialing pause (a **P** appears).

Using the telephone base:

- Lift the corded handset or press , then enter the telephone number.

Predial a call

Using a cordless handset:

- Enter the telephone number using the dialing keys (**0-9**), then press **TALK** or  to dial.

NOTE

- When predialing (preview numbers before dialing), press **DELETE** or **CANCEL** to backspace and delete; press and hold PAUSE to insert a dialing pause (a **P** appears).

Answer a call

Using a cordless handset:

- Press **TALK**, , or any of the dialing key.

Using the telephone base:

- Press , or lift the corded handset.

End a call

Using a cordless handset:

- Press **OFF** or place the handset back in the charger.

Using the telephone base:

- Place the corded handset back to the telephone base.
- If you are using the telephone base speakerphone, press  on the telephone base to end the call.

Make SOS emergency call

Using a cordless handset:

- Press and hold **AUDIO ASSIST/SOS** on the cordless handset for 3 seconds. The telephone base announces, "Emergency mode is activated", and pages all registered devices. All devices ring an alert tone, and after 20 seconds, the telephone starts calling the preset SOS numbers.

NOTES

- If you disable internal SOS alert, the telephone calls the preset SOS numbers in sequence directly when you press and hold **AUDIO ASSIST/SOS**. See page 14 for details.
- When the emergency call is answered, the telephone plays the SOS message to the call receiver, asking the receiver to respond by pressing one of the number keys on his/her phone.
- You can record your own SOS message, or use the default SOS message "This is an emergency call. Please press any number key to start the conversation." See page 12.
- After the call receiver presses a number key, you can then start a conversation with the call receiver.
- The **AUDIO ASSIST/SOS** button on the cordless handset functions as Audio Assist button when on a call or listening to a message or announcement.

Using an Wearable Home SOS Pendant (SN7022) to make emergency call:

- If you have purchased and registered a Wearable home SOS pendant (**SN7022**), press the dial key  on the SOS pendant to call.

Cancel SOS emergency call:

You can cancel an SOS emergency call at any time.

- Press **TALK** or **CANCEL** on the handset; or
- Press and hold **AUDIO ASSIST/SOS** on the handset; or
- Press  on the telephone base; or
- Press the **CANCEL** key on the back of the SOS pendant.

Photo/memory speed dial

If you have set any of the eight direct memory speed dial numbers, you can press a photo speed dial key on the telephone base, or a directory memory key on the handset to quickly dial the preset number.

The telephone base and the cordless handset share the first four direct memory speed dial numbers.

For details on setting photo/memory speed dial, see page 18.

Using a cordless handset:

- Press **M1**, **M2**, **M3** or **M4** on the handset to call.

Using the telephone base:

- Press a photo speed dial key on the telephone base to call.

Handset speakerphone

During a call, press  to switch between speakerphone and normal handset use.

When the speakerphone is active, the cordless handset displays **Speaker**.

Volume

Slide the **VOL** control on the cordless handset or on the telephone base:

- to adjust the speaker volume level when on a call; or
- to adjust the ringer volume when the telephone is ringing.

⚠ CAUTION

- For hearing protection, do not put the cordless handset near your ear when the telephone is ringing. Loud ringer sound may damage your hearing. Adjust the volume to lower the ringer sound if you find it too loud.

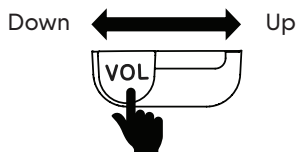

Equalizer

The equalizer on the cordless handset and telephone base enable you to change the quality of the audio for both handset earpiece and speakerphone to best suit your hearing. The default setting is **Natural**.

When on a call:

- Slide the **EQ** button to toggle among **Treble**, **Natural** and **Bass**.

On the cordless handset:

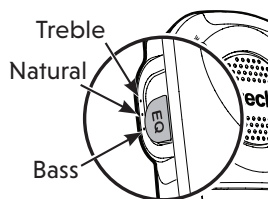

On the telephone base:

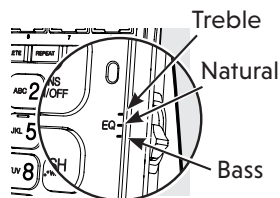

📄 NOTES

- If you switch the call between the handset and the speakerphone by pressing , the audio setting remains unchanged.
- The current equalizer setting remains unchanged until a new setting is selected.

Audio Assist®

The **Audio Assist** feature enhances the clarity and loudness of your caller's voice on the cordless/corded handset earpiece when you are on a call, or listening to a message or an announcement.

To turn on or off Audio Assist on the cordless handset:

- While you are on a call, or listening to a message or an announcement, using the handset earpiece, press **AUDIO ASSIST/SOS** on the handset. The handset briefly displays **Audio assist on**.
- Press **AUDIO ASSIST/SOS** again to turn off. The handset briefly displays **Audio assist off**.

To turn on or off Audio Assist on the telephone base:

- While you are on a call, or listening to a message or an announcement using the corded handset, press **AUDIO ASSIST** on the telephone base.
- Press **AUDIO ASSIST** again to turn off.

Mute

The mute function allows you to hear the other party but the other party cannot hear you.

- During a call, press **MUTE**. The handset displays **Muted** briefly and **MUTE** icon until the mute function is turned off.
- Press **MUTE** again to resume the conversation. The handset displays **Microphone ON** briefly.

Audio Assist® is a registered trademark of Advanced American Telephones.



Join a call in progress

When you are already on an outside call with the cordless handset or the telephone base, the other handset or the telephone base can join the call.

To join a call with a cordless handset:

- Press **TALK** or  to join the call.
- To exit the call, press **OFF** or place the handset in the charger.

To join a call with the telephone base:

- Lift the corded handset or press  to join the call.
- To exit the call, press  or place the handset back to the telephone base.

Call waiting

When you subscribe to call waiting service from your telephone service provider, you hear an alert tone if there is an incoming call while you are already on a call.

- Press **FLASH** to put the current call on hold and take the new call.
- Press **FLASH** at any time to switch back and forth between calls.

If you also subscribe to caller ID service, it will let you see the name and telephone number of the caller during call waiting.

It may be necessary to change your telephone service to use this feature.

Contact your telephone service provide if:

- You have both caller ID and call waiting, but as separate service (you may need to combine these service);
- You have only caller ID service, or only call waiting service; or
- You do not subscribe to caller ID or call waiting services.

There are fees for caller ID services. In addition, services may not be available in all areas.

Chain dialing

Use this feature to initiate a dialing sequence from numbers stored in the phonebook or caller ID log or redial while you are on a call.

Chain dialing can be useful if you wish to access other numbers (such as bank account numbers or access codes) from the phonebook, caller ID log or redial list.

To access a number in the phonebook while on a call:

1. Press **MENU** and then press ▼ or ▲ to select **Phonebook**.
2. Press **SELECT** and then press ▼ or ▲ to scroll to the desired entry.
3. Press **SELECT** to dial the displayed number.

To access a number in the caller ID log while on a call:

1. Press **MENU** and then press ▼ or ▲ to select **Caller ID log**.
2. Press **SELECT** and then press ▼ or ▲ to scroll to the desired entry.
3. Press **SELECT** to dial the displayed number.

To access a number in the redial list while on a call:

1. Press and hold **REDIAL**.
2. Press ▼ or ▲ to browse to the desired entry.
3. Press **SELECT** to dial the displayed number.

NOTE

- Press **CANCEL** to exit redial, phonebook or caller ID log when you are on a call.

Find handset

You can use the Page/Intercom feature to find your misplaced cordless handset.

To start intercom paging:

- Press **PAGE/INTERCOM** on the left side of the telephone base when not in use to make intercom call to the cordless handset.
- If you have two or more handsets, the telephone makes intercom paging to all handsets.

To end intercom paging:

- Press **TALK** or  on the handset to take the intercom call.
- OR-
- Press **PAGE/INTERCOM** on the telephone base.

Redial list

The cordless handset stores the last 10 telephone numbers dialed. Entries are shown in reverse chronological order. When there are already 10 entries, the oldest entry is deleted to make room for the new entry. The telephone base stores the last number dialed only.

Review a redial list entry

Using a cordless handset:

1. Press and hold **REDIAL** when the handset is not in use.
2. Press **▼** or **▲** until the desired entry displays.

Dial a redial list entry

Using a cordless handset:

1. Press and hold **REDIAL** when the handset is not in use.
2. Press **▼** or **▲** until the desired entry displays.
3. Press **TALK** or **☎** to dial.

Using the telephone base:

1. Lift the corded handset.
2. Press and hold **REDIAL** to dial the last number.

Delete a redial list entry

Using a cordless handset:

1. Press and hold **REDIAL** when the handset is not in use.
2. Press **▼** or **▲** to browse to the desired entry.
3. Press **DELETE** to delete the displayed number. You hear a confirmation tone.

Intercom

You can use the intercom feature for conversations between the telephone base and the cordless handset. If you have two or more cordless handsets, you can make intercom calls from the telephone base to all cordless handsets, or from one handset to another or to the telephone base.



NOTE

- Your telephone base supports up to four cordless handsets. You can buy additional expansion handsets (**SN5107**) or photo speed dial handsets (**SN5307**) for this telephone base.

Make intercom call using the cordless handset:

1. Press **MENU**, then press **▼** or **▲** to scroll to **Intercom** and then press **SELECT**.
 - If you have no additional expansion handset or photo speed dial handset, the cordless handset displays **Calling base**. The telephone base rings.
 - If you have other registered handsets, the cordless handset displays **INTERCOM TO:**. Press **▼** or **▲** to choose a desired device and then press **SELECT**.
You may also enter a destination handset number (**1-4**), or press **0** for the telephone base, or press **-tone*** for all devices.



The destination device rings. If you have two or more cordless handsets, the destination handset displays **HANDSET X is calling** or **HANDSET X is calling all**.

- To answer the intercom call on the destination handset, press **TALK** or . The cordless handset displays **Intercom**.
-OR-
To answer the intercom call on the telephone base, lift the corded handset or press .
- To end the intercom call, press **OFF** or place the handset back in the charger. The cordless handset displays **Intercom ended**.
-OR-
To end the intercom call on the telephone base, press  or place the corded handset back in the telephone base.

NOTES

- To cancel the intercom call before it is answered, press **OFF**.
- Press **OFF** or **MUTE** on the cordless handset to temporarily silence the intercom ringer.
- If the destination device is not powered, out of range, on a call, or does not answer the intercom call within 100 seconds, your handset displays **No answer. Try again.** and then returns to idle mode.
- Only one intercom call can be established at a time.

Make intercom call using the telephone base:

- Press **PAGE/INTERCOM**. The telephone base make intercom call to all system devices.
- To answer the intercom call on the destination handset, press **TALK** or . The cordless handset displays **Intercom**.
- To end the intercom call, press  or place the corded handset back in the telephone base.

NOTE

- To cancel the intercom call before it is answered, press **PAGE/INTERCOM**.



Answer an incoming call during an intercom call

When you receive an outside call during an intercom call, there is an alert tone.

- To answer the outside call, press **TALK**. The intercom call ends automatically.
- To end the intercom call without answering the outside call, press **OFF**. The telephone continues to ring.

Call transfer using intercom

Use the intercom feature to transfer an outside call from the cordless handset to the telephone base. You can also share an outside call with the telephone base.

- During a call with the cordless handset, press **MENU**. Then, press **SELECT** to select **Intercom**.
 - If you have no additional expansion handset or photo speed dial handset, the cordless handset displays **Calling base**. The telephone base rings.
 - If you have other registered handsets, the cordless handset displays **INTERCOM TO:**. Press  or  to choose a desired device and then press **SELECT**.
You may also enter a destination handset number (**1-4**), or press **0** for the telephone base, or press **-tone*** for all devices.



The destination device rings. If you have two or more cordless handsets, the destination handset displays **HANDSET X is calling** or **HANDSET X is calling all**.

2. To answer the intercom call on the destination handset, press **TALK** or . The cordless handset displays **Intercom**.

-OR-

To answer the intercom call on the telephone base, press .

NOTES







- To cancel the intercom call before it is answered, press **OFF/CANCEL**.
 - If the destination device is not powered, out of range, on a call, or does not answer the intercom call within 100 seconds, your handset displays **No answer. Try again.** and then returns to idle mode.
3. When the destination device picks up, the outside call is put on hold. Then, you have the following options:
 - You can transfer the call to the destination device.
 - Press **OFF**. Your handset displays **Call transferred**. The destination device is then connected to the outside call.
 - OR-
 - Press **MENU** twice. Your handset displays **Call transferred**. The destination device is then connected to the outside call.
 - You can let the destination handset join you on the outside call in a three-way conversation. Press **MENU**, then press  or  to scroll to **Share call** and then press **SELECT** on the originating handset.
 - You can end the intercom call and continue the outside call with the originating handset. Press **TALK** on your handset to end the intercom call and continue with the outside call.

Phonebook

The phonebook can store up to 50 entries, which are shared by all handsets. Each entry may consist of a telephone number with up to 30 digits, and a name with up to 15 characters.

If the telephone number in the phonebook exceeds 15 digits, a dash appears after the 14th digit and then the remaining digits are shown beginning with a dash, alternately.

Add a phonebook entry

1. Enter the number when the phone is not in use. Press **MENU**, then go to Step 3.
 - OR-
 - Press **MENU** when the phone is not in use, then press  or  to scroll to **Phonebook** and press **SELECT**. Press  or  to scroll to **Add contact**, and then press **SELECT**.
2. When **ENTER NUMBER** displays, use the dialing keys to enter the number.
 - OR-
 - Copy a number from the redial list by pressing and holding **REDIAL** and then press  or  to select a number. Press **SELECT** to copy the number.
3. Press **SELECT** to move on to enter the name. The handset displays **ENTER NAME**.
4. Use the dialing keys to enter the name. Additional key presses show other characters of that particular key. The first character of every word is capitalized.
5. Press **SELECT** to save. The handset displays **Saved to phonebook** and then you hear a confirmation tone.

While entering names and numbers, you can:

- Press **DELETE** to backspace and erase a digit or character.
- Press and hold **DELETE** to erase the entire entry.
- Press ▼ or ▲ to move the cursor to the left or right.
- Press and hold **PAUSE** to insert a dialing pause (for entering numbers only).
- Press **0** to add a space (for entering names only).

Review a phonebook entry

Entries are sorted alphabetically.

1. Press **MENU** on the cordless handset in idle mode to enter the main menu.
2. Press ▼ or ▲ to scroll to **Phonebook** then press **SELECT** twice.
3. Press ▼ or ▲ to browse through the phonebook, or use the dialing keys to start a name search.

Alphabetical search

1. Follow the steps in **Review a phonebook entry** above to enter the phonebook.
2. Use the dialing keys to enter the letter associated with the name. For example, if you have entries for Jenny, Jessie, Kristen and Laura in your phonebook, press **5** (JKL) once to see Jenny (when **Jenny** displays, press ▼ to see Jessie), twice to see Kristen, or three times to see Laura. If there is no name entry matching your search, the next closest match in alphabetical order appears. If necessary, press ▼ or ▲ to browse.

Save a redial entry to the phonebook

1. Press and hold **REDIAL** when the cordless handset is not in use.
2. Scroll to browse through the redial list. When your desired entry displays, press **SELECT**.
3. The handset displays **EDIT NUMBER** and the stored number.
4. Use the dialing keys to edit the number, then press **SELECT**. The handset displays **EDIT NAME** and then the stored name.
5. Use the dialing keys to edit the name. Additional key presses show other characters of that particular key. The first character of every word is capitalized.
6. Press **SELECT** to save. The handset displays **Saved to phonebook** and then you hear a confirmation tone.

Delete a phonebook entry

1. Search for the desired entry in the phonebook (see **Review a phonebook entry** or **Alphabetical search**).
2. When the desired entry appears, press **DELETE**. The handset displays **Delete contact?** and the number.
3. Press **SELECT** to confirm. The handset displays **Contact deleted**. You hear a confirmation tone.

Edit a phonebook entry

1. Search for the desired entry in the phonebook (see **Review a phonebook entry** or **Alphabetical search**).
2. When the desired entry appears, press **SELECT**. The handset displays **EDIT NUMBER** and the stored number.
3. Use the dialing keys to edit the number, then press **SELECT**. The handset displays **EDIT NAME** and then the stored name.
4. Use the dialing keys to edit the name. Additional key presses show other characters of that particular key. The first character of every word is capitalized.
5. Press **SELECT** to save. The handset displays **Saved to phonebook** and then you hear a confirmation tone.

Dial a phonebook entry

1. Search for the desired entry in the phonebook (see **Review a phonebook entry** or **Alphabetical search**).
2. When the desired entry appears, press **TALK** on the handset to dial.

Caller ID

If you subscribe to caller ID service, information about each caller appears after the first or second ring. If you answer a call before the caller information appears on the screen, it will not be saved in the caller ID log.

The caller ID log stores up to 50 entries. Each entry has up to 24 digits for the phone number and 15 characters for the name.

If the telephone number has more than 15 digits, only the last 15 digits appear. If the name has more than 15 characters, only the first 15 characters are shown and saved in the caller ID log.

Entries appear in reverse chronological order. When the caller ID log is full, the oldest entry is deleted to make room for new incoming call information.

NOTE

- This product can provide information only if both you and the caller are in areas offering caller ID service and if both telephone service providers use compatible equipment. The time and date are sent by your telephone service provider along with the call information.

Review a caller ID log entry

1. Press **MENU** on the cordless handset in idle mode to enter the main menu.
2. Press **▼** or **▲** to scroll to **Caller ID log**, and then press **SELECT**.
3. Press **SELECT** again and then press **▼** or **▲** to browse.

Memory match

When the incoming telephone number matches the last seven digits of a telephone number in your phonebook, the screen displays the stored name of the phonebook entry.

For example, if Linda Jones calls, her name appears as **Linda** if this is how you entered it into your phonebook.

NOTE

- The number shown in the caller ID log is in the format sent by the telephone service provider. It usually delivers 10-digit telephone numbers (area code plus phone number). If the last seven digits of the incoming telephone number does not match a number in your phonebook, the name appears as it is delivered by the telephone service provider.

Missed call indicator

When there are calls that have not been reviewed in the caller ID log, the handset displays **XX Missed calls**.

Each time you review a caller ID log entry marked **NEW**, the number of missed calls decreases by one.

When you have reviewed all the missed calls, the missed call indicator no longer displays.

If you do not want to review the missed calls one by one, press and hold **OFF/CANCEL** on the idle handset to erase the missed call indicator. All the entries are then considered old.

Dial a caller ID log entry

- Review the caller ID log entries, and when your desired entry shows on the handset screen, press **TALK** on the handset to dial.

Save a caller ID log entry to the phonebook

1. Review the caller ID log entries, and when your desired entry shows on the handset screen, press **MENU** twice.
2. The handset displays **EDIT NUMBER** and the stored number.
3. Use the dialing keys to edit the number, then press **SELECT**. The handset displays **EDIT NAME** and then the stored name.
4. Use the dialing keys to edit the name. Additional key presses show other characters of that particular key. The first character of every word is capitalized.
5. Press **SELECT** to save. The handset displays **Saved to phonebook** and then you hear a confirmation tone.

While entering names and numbers, you can:

- Press **DELETE** to backspace and erase a digit or character.
- Press and hold **DELETE** to erase the entire entry.
- Press **▼** or **▲** to move the cursor to the left or right.
- Press and hold **PAUSE** to insert a dialing pause (for entering numbers only).
- Press **0** to add a space (for entering names only).

Delete the caller ID log entries

1. Review the caller ID log entries.
2. When the desired caller ID log entry displays, press **DELETE**. You hear a confirmation tone.

To delete all caller ID log entries:

1. Press **MENU** on the cordless handset in idle mode to enter the main menu.
2. Press **▼** or **▲** to select **Caller ID log** and then press **SELECT**.
3. Press **▼** or **▲** to select **Del all calls** then press **SELECT**.
4. The screen displays **Delete all calls?**. Press **SELECT** to confirm. You hear a confirmation tone.

Smart call blocker *

If you have subscribed to caller ID service, then you can use the Smart call blocker feature to screen incoming calls.

Smart call blocker is on, once you install your telephone. It allows all incoming calls to get through and ring by default. You can change the Smart call blocker settings to screen incoming calls.

With call screening active, Smart call blocker screens and filters all incoming calls from numbers or names that are not yet saved in your directory, allow list, block list, or star name list. You can easily add incoming phone numbers to your allow list and block list. This allows you to build up your lists of allowed and blocked numbers, and Smart call blocker will know how to deal with these calls when they come in again.

* Includes licenced Galtel™ technology.

Galtel™ is a trademark of Truecall Group Limited.

Call categories

Calls are classified into four categories. Smart call blocker handles the calls in the following ways:

CALL CATEGORY	CALL CONTROL
<p>Welcome calls</p> <p>Numbers saved in allow list.</p> <p>Numbers saved in phonebook.</p> <p>Numbers not found in block list.</p> <p>Names saved in star name list.</p>	<p>Allow</p> <p>The telephone rings when there is an incoming call with number saved in your allow list or phonebook, but not in your block list. Robocalls with caller names saved in your star name list will also ring.</p>
<p>Unwelcome calls</p> <p>Numbers saved in block list.</p>	<p>Block</p> <p>The telephone does not ring when there is an incoming call with number saved in your block list, and the call will be rejected.</p>

CALL CATEGORY	CALL CONTROL
<p>Calls without numbers</p> <p>Numbers that are "out of area" or set to "Private".</p> <p>Uncategorized calls</p> <p>With absent caller ID number.</p> <p>Numbers not found in phonebook.</p> <p>Numbers not found in allow list.</p> <p>Numbers not found in block list.</p> <p>Caller ID names not found in star name list.</p>	<p>Option 1: Screening with caller name</p> <p>If you have selected this option, the telephone plays the screening announcement, and then asks the caller to say his/her name before the call rings on your telephone. You will then hear the caller's name announced if you have turned on the caller ID announce feature. Then, you can decide whether to accept or reject the call, or to forward the call to the answering system.</p> <p>Option 2: Screening without caller name</p> <p>If you have selected this option, the telephone plays the screening announcement, and then asks the caller to press the pound key (#) before the call rings on your telephone. You can then answer the call.</p> <p>Option 3: Allow (default settings)</p> <p>The telephone allows the calls to get through and ring. The caller's number will not be saved to the allow list.</p> <p>Option 4: Answering system</p> <p>If you have selected this option, the telephone forwards the calls to the answering system without ringing.</p> <p>Option 5: Block</p> <p>If you have selected this option, the telephone rejects the calls with block announcement without ringing. The caller's number will not be saved to the block list.</p>

NOTES

- Smart call blocker is set to on, and to allow all incoming calls by default. When Smart call blocker is on, the first ring of all incoming calls will be muted.
- If your phonebook, allow list, star name list and block list are empty when Smart call blocker is on, and you have set to screen calls, the telephone will screen all incoming calls and asks callers to announce their names or press the pound key (#).
- If Smart call blocker is off, all incoming calls ring, including numbers saved in your block list.

Set Smart call blocker on/off

The Smart call blocker feature is set to on by default.

1. Press **CALL BLOCK** on the cordless handset when it is not in use.
-OR-
Press **MENU** to enter the main menu when it is not in use. Press ▼ or ▲ to scroll to **Smart call blk**, then press **SELECT**.
2. Press **SELECT** again to choose **SCB On/Off**.
3. Press ▼ or ▲ to choose **On** or **Off**, and then press **SELECT**.

Set welcome calls

Add allow list entry:

Add numbers to the allow list that you want to allow their calls to get through to you.

The allow list stores up to 200 numbers.

1. Press **CALL BLOCK** on the cordless handset when it is not in use.
-OR-
Press **MENU** to enter the main menu when it is not in use. Press ▼ or ▲ to scroll to **Smart call blk**, then press **SELECT**.
2. Press ▼ or ▲ to scroll to **Allow list**, and then press **SELECT**.
3. Press ▼ or ▲ to scroll to **Add new entry**, and then press **SELECT**.
4. When **ENTER NUMBER** displays, use the dialing keys to enter the number.
5. Press **SELECT** to move on to enter the name. The handset displays **ENTER NAME**.
6. Use the dialing keys to enter the name. Additional key presses show other characters of that particular key. The first character of every word is capitalized.
7. Press **SELECT** to save. The handset displays **Saved to allow list** and then you hear a confirmation tone.

While entering names and numbers, you can:

- Press **DELETE** to backspace and erase a digit or character.
- Press and hold **DELETE** to erase the entire entry.
- Press ▼ or ▲ to move the cursor to the left or right.
- Press and hold **PAUSE** to insert a dialing pause (for entering numbers only).
- Press **0** to add a space (for entering names only).

Save a caller ID log to allow list:

1. Press **MENU** on the cordless handset in idle mode to enter the main menu.
2. Press ▼ or ▲ to scroll to **Caller ID log**, and then press **SELECT**.
3. Press **SELECT** again and then press ▼ or ▲ to browse.
4. When the desired caller ID log entry displays, press **SELECT**.
5. Press ▼ or ▲ to scroll to **Allow list**, and then press **SELECT**.
6. The handset displays **EDIT NUMBER** and the stored number.
7. Use the dialing keys to edit the number, then press **SELECT**. The handset displays **EDIT NAME** and then the stored name.
8. Use the dialing keys to edit the name. Additional key presses show other characters of that particular key. The first character of every word is capitalized.
9. Press **SELECT** to save. The handset displays **Saved to allow list** and then you hear a confirmation tone.

Review allow list entry:

1. Press **CALL BLOCK** on the cordless handset when it is not in use.
-OR-
Press **MENU** to enter the main menu when it is not in use. Press ▼ or ▲ to scroll to **Smart call blk**, then press **SELECT**.
2. Press ▼ or ▲ to scroll to **Allow list**, and then press **SELECT** twice.
3. Press ▼ or ▲ to browse through the entries.

Edit an allow list entry

1. Search for the desired entry in the allow list (see **Review allow list entry**).
2. When the desired entry appears, press **SELECT**. The handset displays **EDIT NUMBER** and the stored number.
3. Use the dialing keys to edit the number, then press **SELECT**. The handset displays **EDIT NAME** and then the stored name.
4. Use the dialing keys to edit the name. Additional key presses show other characters of that particular key. The first character of every word is capitalized.
5. Press **SELECT** to save. The handset displays **Saved to allow list** and then you hear a confirmation tone.

Delete allow list entry:

1. Press **CALL BLOCK** on the cordless handset when it is not in use.
-OR-
Press **MENU** to enter the main menu when it is not in use. Press ▼ or ▲ to scroll to **Smart call blk**, then press **SELECT**.
2. Press ▼ or ▲ to scroll to **Allow list**, and then press **SELECT** twice.
3. Press **SELECT** ▼ or ▲ to browse through the entries.
4. When the desired entry displays, press **DELETE**. The handset displays **Delete entry?**.
5. Press **SELECT** to confirm.

Delete all allow list entries:

1. Press **CALL BLOCK** on the cordless handset when it is not in use.
-OR-
Press **MENU** to enter the main menu when it is not in use. Press ▼ or ▲ to scroll to **Smart call blk**, then press **SELECT**.
2. Press ▼ or ▲ to scroll to **Allow list**, and then press **SELECT**.
3. Press ▼ or ▲ to scroll to **Delete all**, and then press **SELECT**. The handset displays **Delete all in allow list?**.
4. Press **SELECT** to confirm. The handset displays **Deleted**, and you hear a confirmation tone.

Add star name list entry:

Add names (up to 15 characters) of organizations like schools, medical offices, and pharmacies that use robocalls to communicate important information to you. Their calls will get through to you. The star name list stores up to 10 names.

1. Press **CALL BLOCK** on the cordless handset when it is not in use.
-OR-
Press **MENU** to enter the main menu when it is not in use. Press ▼ or ▲ to scroll to **Smart call blk**, then press **SELECT**.
2. Press ▼ or ▲ to scroll to **Star name list**, and then press **SELECT**.
3. Press ▼ or ▲ to scroll to **Add new entry**, and then press **SELECT**.
4. When **ENTER NAME** displays, use the dialing keys to enter the name. Additional key presses show other characters of that particular key. The first character of every word is capitalized.
5. Press **SELECT** to save. The handset displays **Saved to star name list** and then you hear a confirmation tone.

While entering names, you can:

- Press **DELETE** to backspace and erase a character.
- Press and hold **DELETE** to erase the entire entry.
- Press ▼ or ▲ to move the cursor to the left or right.
- Press **0** to add a space (for entering names only).

Save a caller ID log to star name list:

1. Press **MENU** on the cordless handset in idle mode to enter the main menu.
2. Press ▼ or ▲ to scroll to **Caller ID log**, and then press **SELECT**.
3. Press **SELECT** again and then press ▼ or ▲ to browse.
4. When the desired caller ID log entry displays, press **SELECT**.
5. Press ▼ or ▲ to scroll to **Star name list**, and then press **SELECT**.
6. The handset displays **Star this name?** and then the stored name.
7. Press **SELECT** to save. The handset displays **Saved to star name list** and then you hear a confirmation tone.

Review star name list entry:

1. Press **CALL BLOCK** on the cordless handset when it is not in use.
-OR-
Press **MENU** to enter the main menu when it is not in use. Press ▼ or ▲ to scroll to **Smart call blk**, then press **SELECT**.
2. Press ▼ or ▲ to scroll to **Star name list**, and then press **SELECT** twice.
3. Press ▼ or ▲ to browse through the entries.

Edit a star name list entry

1. Search for the desired entry in the allow list (see **Review star name list entry**).
2. When the desired entry appears, press **SELECT**. The handset displays **EDIT NAME** and then the stored name.
3. Use the dialing keys to edit the name. Additional key presses show other characters of that particular key. The first character of every word is capitalized.
4. Press **SELECT** to save. The handset displays **Saved to star name list** and then you hear a confirmation tone.

Delete star name list entry:

1. Press **CALL BLOCK** on the cordless handset when it is not in use.
-OR-
Press **MENU** to enter the main menu when it is not in use. Press ▼ or ▲ to scroll to **Smart call blk**, then press **SELECT**.
2. Press ▼ or ▲ to scroll to **Star name list**, and then press **SELECT** twice.
3. Press ▼ or ▲ to browse through the entries.
4. When the desired entry displays, press **DELETE**. The handset displays **Delete entry?**
5. Press **SELECT** to confirm.

Delete all star name list entries:

1. Press **CALL BLOCK** on the cordless handset when it is not in use.
-OR-
Press **MENU** to enter the main menu when it is not in use. Press ▼ or ▲ to scroll to **Smart call blk**, then press **SELECT**.
2. Press ▼ or ▲ to scroll to **Star name list**, and then press **SELECT**.
3. Press ▼ or ▲ to scroll to **Delete all**, and then press **SELECT**. The handset displays **Delete all in star name list?**
4. Press **SELECT** to confirm. The handset displays **Deleted**, and you hear a confirmation tone.

Set unwelcome calls

Add block list entry:

Add numbers to the block list that you want to block them from calling. The block list stores up to 1,000 entries.

1. Press **CALL BLOCK** on the cordless handset when it is not in use.
-OR-
Press **MENU** to enter the main menu when it is not in use. Press ▼ or ▲ to scroll to **Smart call blk**, then press **SELECT**.
2. Press ▼ or ▲ to scroll to **Block list**, and then press **SELECT**.
3. Press ▼ or ▲ to scroll to **Add new entry**, and then press **SELECT**.
4. When **ENTER NUMBER** displays, use the dialing keys to enter the number.
5. Press **SELECT** to move on to enter the name. The handset displays **ENTER NAME**.
6. Use the dialing keys to enter the name. Additional key presses show other characters of that particular key. The first character of every word is capitalized.
7. Press **SELECT** to save. The handset displays **Saved to block list** and then you hear a confirmation tone.

While entering names and numbers, you can:

- Press **DELETE** to backspace and erase a digit or character.
- Press and hold **DELETE** to erase the entire entry.
- Press ▼ or ▲ to move the cursor to the left or right.
- Press and hold **PAUSE** to insert a dialing pause (for entering numbers only).
- Press **0** to add a space (for entering names only).

Save a caller ID log to block list:

1. Press **MENU** on the cordless handset in idle mode to enter the main menu.
2. Press ▼ or ▲ to scroll to **Caller ID log**, and then press **SELECT**.
3. Press **SELECT** again and then press ▼ or ▲ to browse.
4. When the desired caller ID log entry displays, press **SELECT**.
5. Press ▼ or ▲ to scroll to **Block list**, and then press **SELECT**.
6. The handset displays **EDIT NUMBER** and the stored number.
7. Use the dialing keys to edit the number, then press **SELECT**. The handset displays **EDIT NAME** and then the stored name.
8. Use the dialing keys to edit the name. Additional key presses show other characters of that particular key. The first character of every word is capitalized.
9. Press **SELECT** to save. The handset displays **Saved to block list** and then you hear a confirmation tone.

Review block list entry:

1. Press **CALL BLOCK** on the cordless handset when it is not in use.
-OR-
Press **MENU** to enter the main menu when it is not in use. Press ▼ or ▲ to scroll to **Smart call blk**, then press **SELECT**.
2. Press ▼ or ▲ to scroll to **Block list**, and then press **SELECT** twice.
3. Press ▼ or ▲ to browse through the entries.

Edit a block list entry

1. Search for the desired entry in the allow list (see **Review block list entry**).
2. When the desired entry appears, press **SELECT**. The handset displays **EDIT NUMBER** and the stored number.
3. Use the dialing keys to edit the number, then press **SELECT**. The handset displays **EDIT NAME** and then the stored name.
4. Use the dialing keys to edit the name. Additional key presses show other characters of that particular key. The first character of every word is capitalized.
5. Press **SELECT** to save. The handset displays **Saved to block list** and then you hear a confirmation tone.

Delete block list entry:

1. Press **CALL BLOCK** on the cordless handset when it is not in use.
-OR-
Press **MENU** to enter the main menu when it is not in use. Press ▼ or ▲ to scroll to **Smart call blk**, then press **SELECT**.
2. Press ▼ or ▲ to scroll to **Block list**, and then press **SELECT** twice.
3. Press ▼ or ▲ to browse through the entries.
4. When the desired entry displays, press **DELETE**. The handset displays **Delete entry?**.
5. Press **SELECT** to confirm.

Delete all block list entries:

1. Press **CALL BLOCK** on the cordless handset when it is not in use.
-OR-
Press **MENU** to enter the main menu when it is not in use. Press ▼ or ▲ to scroll to **Smart call blk**, then press **SELECT**.
2. Press ▼ or ▲ to scroll to **Block list**, and then press **SELECT**.
3. Press ▼ or ▲ to scroll to **Delete all**, and then press **SELECT**. The handset displays **Delete all in block list?**.
4. Press **SELECT** to confirm. The handset displays **Deleted**, and you hear a confirmation tone.

Control calls without numbers

Use this setting to control "out of area" calls or calls with numbers that are set to "Private". You can choose to allow or reject these calls directly. You can also choose to screen them with or without learning the callers' names before you decide whether to answer or reject these calls. Moreover, you can forward these calls to the answering system.

1. Press **CALL BLOCK** on the cordless handset when it is not in use.
-OR-
Press **MENU** to enter the main menu when it is not in use. Press ▼ or ▲ to scroll to **Smart call blk**, then press **SELECT**.
2. Press ▼ or ▲ to scroll to **Calls w/o num**, and then press **SELECT**.
3. Press ▼ or ▲ to choose one of the following options, and then press **SELECT**.
 - **Screening** - ask the caller to press the pound key (#) or to say his/her name before the call rings on your telephone.
 - **Allow** - allow the calls to get through and ring.
 - **Answering sys** - forward the calls to the answering system without ringing.
 - **Block** - reject the calls with block announcement.

4. If you select **Screening**, press ▼ or ▲ to choose one of the following options, and then press **SELECT**.
 - **w/Caller name** - ask the caller to say his/her name before the call rings on your telephone. You can then answer the call, and hear the caller's name announced. You can decide whether to answer or reject the call, or to forward the call to the answering system.
 - **w/o Caller name** - ask the caller to press the pound key (#) before the call rings on your telephone. You can then answer the call.

Control uncategorized calls

Use this setting to control calls with numbers that are not in your phonebook, allow list or block list, or have no caller ID number display. You can choose to allow or reject these calls directly. You can also choose to screen them with or without learning the callers' names before you decide whether to answer or reject these calls. Moreover, you can forward these calls to the answering system.

1. Press **CALL BLOCK** on the cordless handset when it is not in use.
-OR-
Press **MENU** to enter the main menu when it is not in use. Press ▼ or ▲ to scroll to **Smart call blk**, then press **SELECT**.
2. Press ▼ or ▲ to scroll to **Uncategorized**, and then press **SELECT**.
3. Press ▼ or ▲ to choose one of the following options, and then press **SELECT**.
 - **Screening** - ask the caller to press the pound key (#) or to say his/her name before the call rings on your telephone.
 - **Allow** - allow the calls to get through and ring.
 - **Answering sys** - forward the calls to the answering system without ringing.
 - **Block** - reject the calls with block announcement.

4. If you select **Screening**, press ▼ or ▲ to choose one of the following options, and then press **SELECT**.
 - **w/Caller name** - ask the caller to say his/her name before the call rings on your telephone. You can then answer the call, and hear the caller's name announced. You can decide whether to answer or reject the call, or to forward the call to the answering system.
 - **w/o Caller name** - ask the caller to press the pound key (#) before the call rings on your telephone. You can then answer the call.

NOTE

- Robocalls will be classified as uncategorized calls. If you select **Screening**, the telephone screens and filters these calls. It asks the caller to press the pound key (#) or announces his/her name before putting the call through to you. There may be robocalls that you do not want to miss. For example, robocalls with announcements or notices from schools or pharmacies. You can set up your star name list with these caller names to allow their calls to get through to you. See **Add star name list entry** on page 37.

Screening announcements

If you have set to screen calls without numbers and/or screen uncategorized calls, the callers of one or all of the following incoming call categories will hear a screening announcement.

- Calls that are "out of area" or with numbers set to "Private".
- Calls with numbers that are not on your phonebook, allow list, or block list, or with absent caller ID number.
- Calls with caller ID names that are not on your star name list.

The telephone has two screening options, and each option has its default screening announcements.

Screening with caller name - *"Hello. Calls to this number are being screened by Smart call blocker. Please say your name after the tone, then press pound."*

-OR-

Screening without caller name - *"Hello. Calls to this number are being screened by Smart call blocker. If you're a family member, friend or invited caller, please press pound to be connected. If you're a solicitor, please hang up now."* You can use these announcements, or record your own name to replace *"this number"* in both announcements. See **Record your name for all screening announcements**.

Play announcement of screening with caller name:

1. Press **CALL BLOCK** on the cordless handset when it is not in use.
-OR-
Press **MENU** to enter the main menu when it is not in use. Press ▼ or ▲ to scroll to **Smart call blk**, then press **SELECT**.
2. Press ▼ or ▲ to scroll to **Screening annnc**, and then press **SELECT**.

3. Press ▼ or ▲ to scroll to **Play annnc**, and then press **SELECT**.
4. Press ▼ or ▲ to scroll to **w/ Caller name**, and then press **SELECT**.

Play announcement of screening without caller name:

1. Press **CALL BLOCK** on the cordless handset when it is not in use.
-OR-
Press **MENU** to enter the main menu when it is not in use. Press ▼ or ▲ to scroll to **Smart call blk**, then press **SELECT**.
2. Press ▼ or ▲ to scroll to **Screening annnc**, and then press **SELECT**.
3. Press ▼ or ▲ to scroll to **Play annnc**, and then press **SELECT**.
4. Press ▼ or ▲ to highlight to **w/o Caller name**, and then press **SELECT**.

Record your name for all screening announcements:

1. Press **CALL BLOCK** on the cordless handset when it is not in use.
-OR-
Press **MENU** to enter the main menu when it is not in use. Press ▼ or ▲ to scroll to **Smart call blk**, then press **SELECT**.
2. Press ▼ or ▲ to scroll to **Screening annnc**, and then press **SELECT**.
3. Press **SELECT** to select **Rec your name**, and then press **SELECT**. The system announces, *"Record after the tone. Press 5 when you are done."*
4. Speak towards the handset to record your name. Press **5** to end recording.

To listen to the announcement with your recorded name again, scroll to **Play annnc** and press **SELECT**.

Reset all your screening announcements:

1. Press **CALL BLOCK** on the cordless handset when it is not in use.
-OR-
Press **MENU** to enter the main menu when it is not in use. Press ▼ or ▲ to scroll to **Smart call blk**, then press **SELECT**.

2. Press ▼ or ▲ to scroll to **Screening annnc**, and then press **SELECT**.

3. Press ▼ or ▲ to scroll to **Reset annnc**, and then press **SELECT**. The screen shows **Reset to default annnc?**. Press **SELECT** again to confirm. The screen shows **Annnc. reset to default** before returning to the previous menu.

-OR-

1. Press **CALL BLOCK** on the cordless handset when it is not in use.

-OR-

Press **MENU** to enter the main menu when it is not in use. Press ▼ or ▲ to scroll to **Smart call blk**, then press **SELECT**.

2. Press ▼ or ▲ to scroll to **Screening annnc**, and then press **SELECT**.

3. Press ▼ or ▲ to scroll to **Play annnc**, and then press **SELECT**.

4. Press ▼ or ▲ to highlight to **w/ Caller name** or **w/o Caller name**, and then press **SELECT**.

While an announcement is playing, press **DELETE**. The screen shows **Annnc. Deleted** before returning to the previous menu.

Your name will be deleted from all the screening announcements, and the telephone will use the default screening announcements described on page 43.

Voice guide to set Smart call blocker

This feature is an easy and alternative way for you to do the basic setup of Smart call blocker. You can follow the voice guide to set your telephone system to allow or to screen all incoming calls, or to screen calls that do not display a phone number.

1. Press **CALL BLOCK** on the cordless handset when it is not in use.

-OR-

Press **MENU** to enter the main menu when it is not in use. Press ▼ or ▲ to scroll to **Smart call blk**, then press **SELECT**.

2. Press ▼ or ▲ to scroll to **Voice guide**, then press **SELECT**.

3. You hear a voice prompt *"Hello! This voice guide will assist you with the basic setup of Smart call blocker..."*

4. Set up your Smart call blocker feature by inputting the designated numbers, as instructed in the voice guide.

- Press **1** if you want to screen calls with telephone numbers that are not saved in your phonebook, allow list or star name list;
- Press **2** if you only want to screen calls that do not display a phone number; or
- Press **3** if you do not want to screen calls, and want to allow all incoming calls to get through.

NOTES

- You can press **CANCEL** to quit the voice guide at any time.
- After a power outage, the system prompts you to set the date and time. After the date and time setting is done or skipped, the system will prompt if you want to set up Smart call blocker via voice guide. Press **SELECT** to start the setup.

Screen calls without numbers

If Smart call blocker is on, and your telephone is set to screen calls without number, the telephone will not ring when receiving incoming calls that are "out of area" or with numbers set to "Private". It plays a screening announcement to the caller and asks the caller to respond before putting the call through to you.

The telephone has two screening options. You can set your Smart call blocker to screen these calls by asking the callers to record their names and then press the pound key (#). Alternatively, you can screen these calls by only asking the callers to press the pound key (#). See **Screening announcements** on page 43.

NOTES

- The telephone announces to the caller with "Hello. Calls to this number are being screened by Smart call blocker..." If you have recorded your name in the screening announcements, your recorded name will replace "this number" in the announcements. See **Screening announcement** on page 43.
- If the caller hangs up before the call is screened, or without leaving his/her name while the call is being screened, the call will be logged as missed call in the caller ID log.
- While a call is being screened, you can press **TALK** or  on the cordless handset to stop screening and answer the call.
- When the telephone rings and announces the caller's name after screening a call, you can press **OFF** to silence the ringer. You can also press **CALL BLOCK** on the cordless handset or telephone base to reject the call directly, and the caller's number will be added to the block list.
- If you pick up a screened call, the telephone then announces the screening options. You can press **OFF** on the cordless handset to hang up the call. The caller's number will not be added to the block list.

- If you receive a call waiting call without number while on a call, Smart call blocker will not screen the new call. You can press **TALK** or  on the cordless handset to take the new call.
- Robocalls are unable to respond to the screening announcement, and therefore, will not get through and ring. If you want to allow some robocalls to get through, save their names in the star name list. See page 37.
- The telephone can respond to remote access code while it is playing the screening announcement. This allows you to access your answering system from an unknown number remotely. See **Remote access** on page 58.

Options for screened calls without numbers

1. When the telephone starts ringing, and the screen displays **Screened call**, press **TALK** or  on the cordless handset or lift the corded handset on the telephone base to pick up the call. If you have turned on the caller ID announce feature, the telephone announces "You have a call from..." and the caller's name.
2. After you pick up the call, the telephone announces "To answer the call, press 1. To send this call to the answering system, press 4. To repeat these options, press *".

Answer a screened call once only:

- Press **1** on the handset or telephone base to answer the call. The telephone number will not be added to your allow list.

Forward a screened call to the answering system:

- Press **4** on the handset or telephone base to forward the call to the answering system.

NOTE

- The caller is sent to the answering system and can leave a message even if the answering system is off.

End a screened call:

- If you do not want to take the call, press **OFF** on the cordless handset to end the call.

Screen uncategorized calls



If Smart call blocker is on, and your telephone is set to screen uncategorized calls, the telephone will not ring when receiving the following incoming calls:

- Incoming calls with absent caller ID numbers; or
- Incoming calls with numbers that are not in your phonebook, allow list, nor block list; or
- Incoming calls with names that are not in your star name list.

The telephone plays a screening announcement to the caller and asks the caller to respond before putting the call through to you. The telephone has two screening options. You can set your Smart call blocker to screen these calls by asking the callers to record their names and then press the pound key (**#**). Alternatively, you can screen these calls by only asking the callers to press the pound key (**#**). See **Screening announcement** on page 43.

NOTES

- You can set Smart call blocker to screens and filters all uncategorized calls from numbers or names that are not yet saved in your phonebook, allow list, block list, or star name list. You can easily add incoming phone numbers to your allow list and block list. This allows you to build up your lists of allowed and blocked numbers, and Smart call blocker will know how to deal with these calls when they come in again.
- The telephone announces to the caller with *"Hello. Calls to this number are being screened by Smart call blocker..."* If you have recorded your name in the screening announcements, your recorded name will replace *"this number"* in the announcements. See **Screening announcement** on page 43.
- If the caller hangs up before the call is screened, or without leaving his/her name while the call is being screened, the call will be logged as missed call in the caller ID log.

- While a call is being screened, you can press **TALK** or  on the cordless handset to stop screening and answer the call.
- When the telephone rings and announces the caller's name after screening a call, you can press **OFF** to silence the ringer. You can also press **CALL BLOCK** on the cordless handset or telephone base to reject the call directly, and the caller's number will be added to the block list.
- If you pick up a screened call, the telephone then announces the screening options. You can press **OFF** on the cordless handset to hang up the call. The caller's number will not be added to the block list.
- If the Smart call blocker feature is on and in screening mode, and you receive a call waiting call:
 - If you have already picked up a screened call, the telephone checks whether the call waiting call's number can be found in the phonebook, block list or allow list. It also checks whether the caller name is in the star name list. After that, the telephone displays the caller ID information or **Blocked call** accordingly. You can press **TALK** or  on the cordless handset to take the new call.
 - If the telephone is screening a call, the call waiting call will be ignored and logged as missed call in the caller ID log.
- Robocalls are unable to respond to the screening announcement, and therefore, will not get through and ring. If you want to allow some robocalls to get through, save their names in the star name list. See page 37.
- The telephone can respond to remote access code while it is playing the screening announcement. This allows you to access your answering system from an unknown number remotely. See **Remote access** on page 58.

Options for screened uncategorized calls

1. When the telephone starts ringing, and the screen displays **Screened call**, press **TALK** or  on the cordless handset or lift the corded handset to pick up the call. If you have turned on the caller ID announce feature, the telephone announces "You have a call from..." and the caller's name.
2. After you pick up the call, the telephone announces "To answer the call, press 1. To answer and always allow this number, press 2. To block this number, press 3. To send this call to the answering system, press 4. To repeat these options, press *".

Answer a screened call once only:

- Press **1** on the handset or telephone base to answer the call. The telephone number will not be added to your allow list.

Answer and always allow a screened call:

- Press **2** on the handset or telephone base to answer the call. The telephone number will be added to your allow list.

Block a screened call:

- Press **3** or **CALL BLOCK** on the cordless handset or telephone base to block the call. The telephone plays the block announcement "The number you are calling is not accepting your call. Please hang up." to the caller. The telephone number will be added to your block list.

Forward a screened call to the answering system:

- Press **4** on the cordless handset or telephone base to forward the call to the answering system.

NOTE

- The caller is sent to the answering system and can leave a message even if the answering system is off.

End a screened call:

- If you do not want to take the call, press **OFF** on the cordless handset to end the call.

Option while on a screened call

When you are on a call and speaking to the caller, and you do not want to continue the call, you can end the call with block announcement and add the number to the block list.

Press **CALL BLOCK** on the handset or the telephone base to end the call. The telephone plays the block announcement *"The number you are calling is not accepting your call. Please hang up."* to the caller, and the call will be terminated. The caller's number will be added to your block list.

- Press **CALL BLOCK**. The handset screen displays **Block and end?** and the caller's number, if available. Press **SELECT** to end the call.

NOTES

- The caller's number, if available, will be saved to the block list. The screen displays **Added to block list** after pressing **CALL BLOCK**, then press **SELECT**. If caller's number is not available, the screen displays **No number available to block**.
- You can press **CALL BLOCK** to end the call even if Smart call blocker is turned off.

Sound settings

Key tone

The cordless handset is set to beep with each key press. You can adjust the key tone volume or turn it off. If you turn off the key tone, there are no beeps when you press keys.

1. Press **MENU** on the cordless handset in idle mode to enter the main menu.
2. Press **▼** or **▲** to choose **Settings** and then press **SELECT**.
3. Press **▼** or **▲** to choose **Key tone**, then press **SELECT**.
4. Press **▼** or **▲** to sample each volume level, then press **SELECT** to save. You hear a confirmation tone.

Handset and base ringer tone

You can choose from different ringer tones for the cordless handset and telephone base.

1. Press **MENU** on the cordless handset in idle mode to enter the main menu.
2. Press **▼** or **▲** to choose **Ringers** and then press **SELECT**.
3. Press **▼** or **▲** to choose **Handset** or **Base**, and then press **SELECT**.
4. Press **▼** or **▲** to choose **Ringer tone**, then press **SELECT**.
5. Press **▼** or **▲** to sample each ringer tone.
6. Press **SELECT** to save. You hear a confirmation tone.

NOTE

- If you turn off the ringer volume, you will not hear ringer tone samples.

Handset and base ringer volume

You can adjust the cordless handset and telephone base ringer volume levels, or turn the ringer off.

If you turn both handset and base ringer off, the caller ID will not be announced.

1. Press **MENU** on the cordless handset in idle mode to enter the main menu.
2. Press **▼** or **▲** to choose **Ringers** and then press **SELECT**.
3. Press **▼** or **▲** to choose **Handset or Base**, and then press **SELECT**.
4. Press **SELECT** again to choose **Ringer volume**.
5. Press **▼** or **▲** to sample each ringer volume level.
6. Press **SELECT** to save. You hear a confirmation tone.

-OR-

Slide the **VOL** control on the cordless handset or on the telephone base to adjust the volume.

CAUTION

- For hearing protection, do not put the cordless handset near your ear when the telephone is ringing. Loud ringer sound may damage your hearing. Adjust the volume to lower the ringer sound if you find it too loud.



NOTES

- If the ringer volume is set to **Off**, the idle screen displays  and **Ringer off**.
- When the ringer volume is set to **Off**, the handset still rings when you press **PAGE/INTERCOM** at the telephone base.

Temporary ringer silencing

When the telephone is ringing, you can temporarily silence the ringer without disconnecting the call. The next call rings normally at the preset volume.

To silence the handset ringer:

- Press **MUTE** or **CANCEL** on the cordless handset. The handset displays  and **Ringer muted**.

To silence the base ringer:

- Press **MUTE** on the telephone base.

About the built-in answering system and voicemail service

For message recording, your telephone has a built-in answering system, and it also supports voicemail service offered by your telephone service provider (subscription is required, and fee may apply).

The main differences between them are:

CATEGORY	BUILT-IN ANSWERING SYSTEM	VOICEMAIL FROM TELEPHONE SERVICE
Storage	Messages are stored in the telephone base.	Messages are stored in a server or system provided by your telephone service provider.
	Your messages will not be deleted automatically. You have to delete your messages manually.	Your messages may be automatically deleted after a period of time. Contact your telephone service provider for more details.
Method to retrieve messages	When you received new messages, the handset displays XX New messages , and the red LED light on the telephone base flashes.	When you received new messages, the handset displays  and New voicemail .
Method to retrieve messages	To retrieve messages, usually there are two ways: <ul style="list-style-type: none"> • Press ▶/■ on the telephone base; or • Access remotely with an access code. 	To retrieve messages, you need an access number and/or a passcode provided by your telephone service provider.

Set your built-in answering system

The answering system can record and store up to 99 messages. Each message can be up to three minutes in length.

The total storage capacity for the announcement, messages and memos is approximately 22 minutes. The actual recording time depends on individual message characteristics.

Your answering system allows you to set your announcement, to save and delete messages, activate call screening, to set number of rings before pick up, to access remotely, and to control the recording time.

Turn the answering system on or off

The answering system must be turned on to answer and record messages.

When the answering system is turned on, the red LED light next to **ANS ON/OFF** on the telephone base turns on.

To turn on or off with the telephone base:

- Press **ANS ON/OFF** to turn the built-in answering system on or off. When the answering system is turned on, it announces, *"Calls will be answered."* When the answering system is turned off, it announces, *"Calls will not be answered."*

To turn on or off with the cordless handset:

1. Press **MENU** on the cordless handset in idle mode to enter the main menu.
2. Press **▼** or **▲** to choose **Answering sys** and then press **SELECT**.
3. Press **▼** or **▲** to choose **Answer ON/OFF** and then press **SELECT**.
4. Press **▼** or **▲** to choose **On** or **Off** and then press **SELECT** to save. You hear a confirmation tone.

Default announcement

The telephone is preset with a greeting that answers calls with *"Hello, please leave a message after the tone."* You can use this preset announcement, or replace it with your own.

Record your own announcement

The announcement can be up to 90 seconds in length.

1. Press **MENU** on the cordless handset in idle mode to enter the main menu.
2. Press **▼** or **▲** to choose **Answering sys** then press **SELECT**.
3. Press **SELECT** to select **Announcement**.
4. Press **SELECT** to select **Record annc**.
5. The handset announces, *"Record after the tone. Press STOP when you are done."* After the tone, speak towards the handset microphone.
6. Press **5** when finished. The handset plays back the recorded announcement.

NOTE

- Announcements shorter than two seconds will not be recorded.

Play the announcement

1. Press **MENU** on the cordless handset in idle mode to enter the main menu.
2. Press **▼** or **▲** to choose **Answering sys** then press **SELECT**.
3. Press **SELECT** to select **Announcement**.
4. Press **▼** or **▲** to choose **Play annc** then press **SELECT**.

Options during playback:

- Press **VOL+** or **VOL-** to adjust the listening volume.
- Press **5** or **OFF** to stop at any time.
- Press  to switch between the speakerphone and the handset earpiece.

Delete the announcement

1. Press **MENU** on the cordless handset in idle mode to enter the main menu.
2. Press **▼** or **▲** to choose **Answering sys** then press **SELECT**.
3. Press **SELECT** to select **Announcement**.
4. Press **▼** or **▲** to choose **Reset annc** then press **SELECT**. The screen shows **Reset to default annc?**. Press **SELECT** again to confirm. The screen shows **Annc. reset to default** before returning to the previous menu.

- OR -

1. Press **MENU** on the cordless handset in idle mode to enter the main menu.
2. Press **▼** or **▲** to choose **Answering sys** then press **SELECT**.
3. Press **SELECT** to select **Announcement**.
4. Press **▼** or **▲** to choose **Play annc** then press **SELECT**.
5. While it plays the announcement, press **DELETE**. The handset displays **Annc. reset to default**.

NOTE

- After you deleted your own recorded announcement, the answering system answers calls with the default announcement.

Voice guide to set Answering system

This feature is an alternative way for you to do the basic setup of the answering system. You can follow the voice guide to record your own announcement, set the number of rings, and set the message alert tone.

1. Press **MENU** on the cordless handset in idle mode to enter the main menu.
2. Press **▼** or **▲** to choose **Answering sys** and then press **SELECT**.
3. Press **▼** or **▲** to choose **Voice guide** and then press **SELECT**. You hear a voice prompt, *"This voice guide will assist you with the basic setup of your answering system."*
4. Setup your answering system by inputting designated numbers, as instructed in the voice guide.

NOTES

- You can press **CANCEL** on the cordless handset to quit the voice guide at any time.
- After a power outage, the system prompts you to set the date and time, and Smart call blocker. After these settings are done or skipped, the system prompts if you want to set up the answering system via voice guide. Press **SELECT** to start the setup.

Set number of rings

You can set the answering system to answer an incoming call after two, three, four, five or six rings; or toll saver.

If you choose toll saver, the answering system answers a call after two rings when you have new messages, or after four rings when you have no new messages. This enables you to check for new messages and avoid paying unnecessary long distance charges if you are calling from outside your local area.

1. Press **MENU** on the cordless handset in idle mode to enter the main menu.
2. Press **▼** or **▲** to choose **Answering sys** and then press **SELECT**.
3. Press **▼** or **▲** to choose **Ans sys setup** and then press **SELECT**.
4. Press **▼** or **▲** to choose **# of rings** and then press **SELECT**.
5. Press **▼** or **▲** to choose **6, 5, 4, 3, 2** or **Toll saver** and then press **SELECT** to save. You hear a confirmation tone.

Set recording time

You can set the recording time for each incoming message.

1. Press **MENU** on the cordless handset in idle mode to enter the main menu.
2. Press **▼** or **▲** to choose **Answering sys** and then press **SELECT**.
3. Press **▼** or **▲** to choose **Ans sys setup** and then press **SELECT**.
4. Press **▼** or **▲** to choose **Recording time** and then press **SELECT**.
5. Press **▼** or **▲** to choose **3 minutes, 2 minutes** or **1 minute**, and then press **SELECT** to save. You hear a confirmation tone.

Turn the call screening on or off

You can hear incoming messages at the telephone base while they are being recorded.

1. Press **MENU** on the cordless handset in idle mode to enter the main menu.
2. Press ▼ or ▲ to choose **Answering sys** and then press **SELECT**.
3. Press ▼ or ▲ to choose **Ans sys setup** and then press **SELECT**.
4. Press **SELECT** to select **Call screening**.
5. Press ▼ or ▲ to choose **On** or **Off**, and then press **SELECT** to save. You hear a confirmation tone.

Turn the message alert tone on or off

When the message alert tone is set to on, and there is at least one new message, the telephone base beeps every 10 seconds.

1. Press **MENU** on the cordless handset in idle mode to enter the main menu.
2. Press ▼ or ▲ to choose **Answering sys** and then press **SELECT**.
3. Press ▼ or ▲ to choose **Ans sys setup** and then press **SELECT**.
4. Press ▼ or ▲ to choose **Msg alert tone**, and then press **SELECT**.
5. Press ▼ or ▲ to choose **On** or **Off**, and then press **SELECT** to save. You hear a confirmation tone.

NOTES

- The answering system must be turned on for the message alert tone to be functional.
- Press any key on the telephone base (except **PAGE/INTERCOM**) to temporarily silence the message alert tone.

Use your built-in answering system

New message indication

When there are new answering system messages, the handset displays **XX New messages**, and the message window on the telephone base flashes. When you are reviewing a new message, **NEW** displays on the handset.

MESSAGE WINDOW DISPLAY	DESCRIPTION
0	No messages.
1-99	Total number of old messages and memos recorded. The message number currently playing.
0-99 (flashing)	Total number of new messages recorded, or the current message number during new message playback. The clock needs to be set.
1-99 & F (alternating)	The answering system memory is full with total number of messages recorded.
1-8	The telephone base speaker volume level while adjusting.
0-6	The telephone base ringer level while adjusting.
.....	The answering system is answering a call, or recording a memo or announcement. The handset is on a call, or in the caller ID log. The answering system is being accessed remotely.

If the message alert tone is turned on, the telephone base beeps every 10 seconds when there are messages that have not been reviewed.

Message playback

If you have new messages, the telephone plays only the new messages (oldest first). If there are no new messages, the telephone plays back all messages (oldest first). If there are both new and old messages, you have the options of playing the new or old messages.

When playback begins, you hear the total number of messages followed by the date and time of the message. After the last message, the telephone announces, "End of messages."

NOTE

- Make sure you set the date and time correctly. Refer to **Set date and time** under the **Configure your telephone** section for more details.

To playback messages with the cordless handset:

1. When the handset is not in use, press **MENU** twice to choose **Play messages**.
2. If you have only new or old messages, the messages play automatically.
-OR-
If you have both new and old messages, press ▼ or ▲ to scroll to **Play new msgs** or **Play old msgs**, then press **SELECT**.

Options during playback:

- Slide the **VOL** control to adjust the listening volume.
- Press  to switch between the speakerphone and the handset earpiece.
- Press **6** to skip to the next message.
- Press **4** to repeat the playing message. Press **4** twice to listen to the previous message.

- Press **DELETE** to delete the playing message. The handset announces, "Message deleted," and then advances to the next message.
- Press **TALK** to call back the caller. The handset displays **Call back?**. Press **SELECT** to confirm or press **OFF** to cancel.
- Press **SELECT** to pause the playback and view the caller's information. Then you can press **TALK** or  to call back.

To playback messages at the telephone base:

- Press  when the phone is not in use. When you have no message in the answering system, the telephone base announces, "You have no message."

Options during playback:

- Slide the **VOL** control to adjust the listening volume.
- Press **REPEAT** to repeat the playing message. Press **REPEAT** twice to listen to the previous message.
- Press **DELETE** to delete the playing message. The telephone base announces, "Message deleted," and then advances to the next message.
- Press  to stop the playback.
- Press **SLOW** to reduce the playback speed.

Delete all messages

You can only delete old (reviewed) messages. You cannot delete new messages until you review them. You cannot retrieve deleted messages.

To delete all messages with the telephone base:

1. Press **DELETE** when the phone is not in use. The system announces, *"To delete all old messages, press DELETE again."*
2. Press **DELETE** immediately. The system announces, *"All old messages deleted."* You hear a confirmation tone.

To delete all messages with the cordless handset:

1. Press **MENU** on the cordless handset in idle mode to enter the main menu.
2. Press **▼** or **▲** to choose **Answering sys** and then press **SELECT**.
3. Press **▼** or **▲** to choose **Delete all old** and then press **SELECT**. The handset displays **Delete all old messages?**.
4. Press **SELECT** to confirm. The handset displays **Deleting...** and then **All old msgs deleted!**. You hear a confirmation tone.

Call screening

To screen a call at the telephone base:

If the answering system and call screening are on, the announcement and the incoming message broadcast at the telephone base while the call is answered by the answering system.

Options while a message is being recorded:

- Slide the **VOL** control to adjust the listening volume.
- Press **▶/■** to temporarily turn off the call screening.

To screen a call at the cordless handset:

If the answering system is on and your answering system is recording a message, press **SELECT** to screen the call on your handset. The announcement and the incoming message broadcast at the handset while the call is answered by the answering system.

Options while a message is being recorded:

- Slide the **VOL** control to adjust the listening volume.
- Press **OFF** to temporarily turn off the feature.
- Press **SELECT** to temporarily turn on the feature if it is set to off.

Call intercept

If you want to talk to the person whose message is being recorded, press **TALK** or  on the cordless handset.

Record, play or delete memos

Memos are your own recorded messages used as reminders for yourself or others using the same answering system. You can record your own memos using a system handset. Playback and delete them in the same way as incoming messages.

1. Press **MENU** on the cordless handset in idle mode to enter the main menu.
2. Press **▼** or **▲** to choose **Answering sys** and then press **SELECT**.
3. Press **▼** or **▲** to choose **Record memo** and then press **SELECT**.
The handset announces, *"Record after the tone. Press STOP when you are done."*
4. Speak towards the handset microphone. Press **5** when you finish recording. The handset announces *"Recorded."*

NOTES

- If you record a memo when the answering system memory is full, the system announces, *"Memory is full."*
- Each memo can be up to four minutes in length. Memos shorter than two second are not recorded.

Use the built-in answering system and voicemail service

You can use your answering system and voicemail service together by setting your answering system to answer before voicemail service answers as described below. To learn how to program your voicemail settings, contact your telephone service provider.

If you are on a call, or if the answering system is busy recording a message and you receive another call, the second caller can leave a voicemail message.

Set your answering system to answer calls at least two rings earlier than your voicemail service is set to answer. For example, if your voicemail service answers after six rings, set your answering system to answer after four rings. Some voicemail service providers may program the delay before answering calls in seconds instead of rings. In this case, allow six seconds per ring when determining the appropriate setting.

Retrieve voicemail from telephone service

Voicemail is a feature available from most telephone service providers. It may be included with your telephone service, or may be optional. Fees may apply.

Retrieve voicemail

When you received a voicemail, the handset displays  and **New voicemail**. To retrieve, you typically dial an access number provided by your telephone service provider, and then enter a security code. Contact your telephone service provider for instructions on how to configure the voicemail settings and listen to messages.

NOTE

- After you have listened to all new voicemail messages, the indicators on the handset turn off automatically.

Set your voicemail number

You can save your access number for easy access to your voicemail.

After you saved the voicemail number, you can press and hold  **1** to retrieve voicemail.

1. Press and hold  **1** when the handset is not in use.
2. Use the dialing keys to enter the voicemail number (up to 30 digits).
3. Press **SELECT** to save. The handset displays **Voicemail # saved**. You hear a confirmation tone.

-OR-

1. Press **MENU** on the cordless handset in idle mode to enter the main menu.
2. Press **▼** or **▲** to choose **Settings** and then press **SELECT**.

3. Press **▼** or **▲** to choose **Voicemail #** and then press **SELECT**.
4. Use the dialing keys to enter the voicemail number (up to 30 digits).
5. Press **SELECT** to save. The handset displays **Voicemail # saved**. You hear a confirmation tone.

While entering numbers, you can:

- Press **DELETE** to backspace and erase a digit.
- Press and hold **DELETE** to erase the entire entry.
- Press **▼** or **▲** to move the cursor to the left or right.
- Press and hold **PAUSE** to insert a dialing pause.

Turn off the new voicemail indicators

If you have retrieved your voicemail while away from home, and the handset still displays the new voicemail indicators, use this feature to turn off the indicators.

NOTE

- This feature turns off the indicators only, it does not delete your voicemail messages.
1. Press **MENU** on the cordless handset in idle mode to enter the main menu.
 2. Press **▼** or **▲** to choose **Settings** and then press **SELECT**.
 3. Press **▼** or **▲** to choose **Clr voicemail** and then press **SELECT**.
 4. The screen displays **Reset Voicemail Indicator?**. Press **SELECT** to confirm. You hear a confirmation tone.

Remote access

A two-digit security code is required to access the answering system remotely from any touch-tone telephone. The preset code is **19**. You can use this preset code, or set your own.

Access your answering system remotely

1. Dial your telephone number from any touch-tone telephone.
2. Enter the two-digit security code after the announcement and the long beep.
3. Enter one of the following remote commands.

COMMAND	DESCRIPTION
1	Play all messages.
2	Play only new messages.
3	Delete the current message (during playback).
33	Delete all old messages.
4	Repeat the current message (during playback).
5	Stop.
*5	Hear a list of remote commands.
6	Skip to the next message (during playback).
*7	Record a new announcement.
8	End the call.
0	Turn the answering system on or off.

4. Hang up or press **8** to end the call.

NOTES

- If you do not press any key within 20 seconds, the remote access call automatically disconnects.
- When the answering system memory is full, the telephone announces, "Memory is full. Enter the remote access code."
- When the answering system is turned off, the telephone answers after 10 rings, and announces, "Please enter your remote access code."

Set your remote access code

You can set your own remote access code from **00** to **99**.

1. Press **MENU** on the cordless handset in idle mode to enter the main menu.
2. Press ▼ or ▲ to choose **Answering sys** and then press **SELECT**.
3. Press ▼ or ▲ to choose **Ans sys setup** and then press **SELECT**.
4. Press ▼ or ▲ to choose **Remote code** and then press **SELECT**.
5. Press the dialing keys (**0-9**) to enter the code, or ▼ or ▲ to select from **00** to **99**, then press **SELECT** to save. You hear a confirmation tone.

Expand your telephone system

Add and register expansion handset

You can add new cordless handsets (**SN5107**, purchased separately) to expand your telephone system. Your telephone base supports a maximum of four cordless handsets.

Additional handsets are assigned numbers in the sequential order.

Charge the new handset without interruption for at least 30 minutes before registering it to the telephone base.

After charged, each expansion handset displays **To register HS, see manual**.

NOTES

- You cannot register a handset if any other system device is in use.
- Only one handset can register to the telephone base at a time.

To register a SN5107 handset:

1. When the telephone is not in use, press and hold **PAGE** at the telephone base for about five seconds until the visual ringer indicator light turns on. Release **PAGE**.
2. Place the new or non-registered handset in the handset charger. The handset displays **Registering... Please wait**.

The handset show **Registered** and you hear a beep when the registration process completes. The registration process takes about 60 seconds to complete.

If the registration fails, the handset displays **Registration failed**, and then **To register HS, see manual**. Remove the handset from the charger and repeat the registration process again.

Add and register photo speed dial handset

You can add a new photo speed dial handset (**SN5307**, purchased separately) to your telephone system. The **SN5307** cordless photo speed dial handset lets you quickly dial one of the four preset numbers by just pressing the photo speed dial key.

If you have already set the photo speed dial keys **1**, **2**, **3** and **4** on the telephone base, the same numbers will be automatically set for the dial keys of your newly registered photo speed dial handset.

You can register a maximum of four cordless handsets.

NOTES

- You cannot register a handset if any other system device is in use.
- Only one handset can register to the telephone base at a time.

To register a SN5307 handset:

1. When the telephone is not in use, press and hold **PAGE** at the telephone base for about five seconds until the visual ringer indicator light turns on. Release **PAGE**.
2. Put the handset in its charger. The handset **CHARGE** light alternates red and green quickly to indicate the registration is in progress.

You hear a beep when the registration process completes. The registration process takes about 60 seconds to complete.

If registration fails, you hear an error tone, and the **CHARGE** light alternates red and green slowly when it is taken out of the charger. Start again from Step 1 above.

Device setup

You can add VTech compatible Cordless audio doorbell, ULE Cordless extension ringer and ULE Wearable home SOS pendant (**SN7021**, **SN7014** and **SN7022**, all purchased separately) to your telephone system.

The Cordless audio doorbell (**SN7021**) helps you get notified at your telephone system upon visitors' arrival. When a visitor presses the Audio doorbell, both the base and the handset will play the chime tone, and you can then answer the doorbell call and talk to the visitor at your door with the handset or base. For operation instructions, refer to page 62 to page 64.

VTech compatible ULE devices



The ULE Cordless extension ringer (**SN7014**) works as an extra ringer and/or flashing lights in addition to your handset and base. It lets you hear and see more clearly when there is an incoming call.

The ULE Wearable home SOS pendant (**SN7022**) function as same as the SOS button of your cordless handset. It acts as a handy pendant to let you quickly call the preset SOS numbers for help in an emergency, even when your telephone is beyond your reach. For detailed setups and operations, refer to **Set SOS emergency call** section on page 12 to page 14, and **Make SOS emergency call** section on page 23.

NOTE

- You can add a maximum of two Cordless audio doorbells and 30 compatible ULE devices to your telephone base.

Add and register a new device

NOTES

- You need to register your newly purchased devices to the telephone base before use.
- Make sure the new devices are powered on with batteries or with AC power before registering them to the telephone base.

To register an Extension ringer (**SN7014**):

- When the telephone is not in use, press and hold **PAGE** at the telephone base for about five seconds until the visual ringer indicator light turns on. Release **PAGE**.
- Press and hold the pair button  on the right side of the extension ringer until the green LED light on the front flashes, then release the button. When registration is successful, the green LED light becomes steady on, and then the base beeps once.

It takes up to 60 seconds to complete the registration. When the registration is successful, the green LED light on the Extension ringer turns to steady on, and the telephone base beeps and its visual ringer indicator light turns off.

If registration fails, start again from Step 1 above.

For detailed installation and operation instructions, refer to the user's manual of your Extension ringer.

To register an Audio doorbell:

1. When the telephone is not in use, press and hold **PAGE** at the telephone base for about five seconds until the visual ringer indicator light turns on. Release **PAGE**.
2. Press and hold the pair button on the back of the audio doorbell until the chime button LED light flashes, then release the button. When registration is successful, the chime button LED light becomes steady on, and then the base beeps once.

It takes up to 60 seconds to complete the registration. When the registration is successful, the chime button LED light on the front of the Audio doorbell turns to steady on, and the telephone base beeps and its visual ringer indicator light turns off.

If registration fails, start again from Step 1 above.

For detailed installation and operation instructions, refer to the **Audio doorbell** section in this user's manual, and the user's manual of your Cordless audio doorbell.

To register a Wearable home SOS pendant:

1. When the telephone is not in use, press and hold **PAGE** at the telephone base for about five seconds until the visual ringer indicator light turns on. Release **PAGE**.
2. Press and hold **CANCEL** on the back of the SOS pendant until the LED light on the front flashes, then release the button. When registration is successful, the LED light turns off, and then the base beeps once.

It takes up to 60 seconds to complete the registration. When the registration is successful, the red LED lights on the SOS pendant turns off, and the telephone base beeps and its visual ringer indicator light turns off.

If registration fails, start again from Step 1 above.

For detailed installation and operation instructions, refer to the **SOS emergency call section** in this manual, and the user's manual of your Wearable home SOS pendant.

Audio doorbell

(Model SN7021 , purchased separately)

If you have purchased and registered an Cordless audio doorbell (**SN7021**) to the telephone base, the **Doorbell** sub-menu option appears in the **Set device** menu of the cordless handset. You can set up your Cordless audio doorbell, for example, set the chime volume and tone, and divert doorbell calls to a preset number. You can also record doorbell calls.

Set chime volume

1. Press **MENU** on the cordless handset in idle mode to enter the main menu.
2. Press **▼** or **▲** to choose **Set device** and then press **SELECT**.
3. Press **▼** or **▲** to choose **Doorbell** and then press **SELECT**.
4. Press **SELECT** to select **Chime**.
5. Press **SELECT** again to select **Chime volume**.
6. Press **▼** or **▲** to choose from **Volume 1** to **Volume 5** and then press **SELECT** to save.

Set chime tone

1. Press **MENU** on the cordless handset in idle mode to enter the main menu.
2. Press **▼** or **▲** to choose **Set device** and then press **SELECT**.
3. Press **▼** or **▲** to choose **Doorbell** and then press **SELECT**.
4. Press **SELECT** to select **Chime**.
5. Press **SELECT** again to select **Chime tone**.
6. Press **▼** or **▲** to choose from **Tone 1** to **Tone 5**, or **Off**, and then press **SELECT** to save.

Answer, decline or record a doorbell call

When a visitor presses your Audio doorbell, all your devices chime and the handset screen shows **Doorbell X is ringing**. You can answer the doorbell call and talk to the visitor at your door with the handset or base.

Answer a doorbell call

Using a cordless handset:

- Press **TALK** on a cordless handset to answer.

Using the telephone base:

- Press  on the telephone base or lift the corded handset to answer.

NOTE

- After you press **TALK** on the cordless handset to answer the doorbell, the handset screen displays **Speak to DOORBELL X**. You can then talk with the visitor at your door.

Decline a doorbell call

Using a cordless handset:

- When the chime tone is ringing, press **OFF** on the handset.

Record a doorbell call

You can record conversations between you at the telephone and the visitor at your door, after you answer the doorbell call with the telephone. Your telephone is set to record all doorbell calls by default. You can disable the setting.

Using a cordless handset:

1. Press **MENU** on the cordless handset in idle mode to enter the main menu.
2. Press ▼ or ▲ to choose **Set device** and then press **SELECT**.
3. Press ▼ or ▲ to choose **Doorbell** and then press **SELECT**.
4. Press ▼ or ▲ to choose **Record DB call** and then press **SELECT**.
5. Press ▼ or ▲ to choose **On** to record doorbell call, or choose **Off** to turn off, and then press **SELECT** to save.

NOTE

- Recorded doorbell calls are stored as voice messages. See **Message playback** section on page 54 to retrieve your doorbell call conversations.

Divert doorbell calls

You can divert all doorbell calls to a preset external number, or decline a doorbell call and forward the doorbell call to the preset external number.

Set call divert number

1. Press **MENU** on the cordless handset in idle mode to enter the main menu.
2. Press ▼ or ▲ to choose **Set device** and then press **SELECT**.
3. Press ▼ or ▲ to choose **Doorbell** and then press **SELECT**.
4. Press ▼ or ▲ to choose **Dbell divert** and then press **SELECT**.
5. Press ▼ or ▲ to choose **Preset number** and then press **SELECT**.
6. When **PRESET NUMBER** displays, use the dialing keys to enter the number. Press **SELECT** to save.

While entering numbers, you can:

- Press **DELETE** to backspace and erase a digit.
- Press and hold **DELETE** to erase the entire entry.
- Press ▼ or ▲ to move the cursor to the left or right.
- Press and hold **PAUSE** to insert a dialing pause (for entering numbers only).

NOTE

- When a visitor presses the doorbell and the doorbell call is diverted to the preset number, the call receiver of the preset number hears the message *"This is a diverted call from doorbell. Please press any number key to start the conversation."* You can also set the telephone to record all doorbell call conversations. See **Record doorbell call** on page 63.

Set auto call divert to preset number

1. Press **MENU** on the cordless handset in idle mode to enter the main menu.
2. Press ▼ or ▲ to choose **Set device** and then press **SELECT**.
3. Press ▼ or ▲ to choose **Doorbell** and then press **SELECT**.
4. Press ▼ or ▲ to choose **Dbell divert** and then press **SELECT**.
5. Press **SELECT** to select **Divert mode**.
6. Press ▼ or ▲ to choose **Auto divert** and then press **SELECT** to save.

Set decline call divert to preset number

You can also set up call divert to the preset number, only when you press **OFF** on your handset to decline the doorbell call.

1. Press **MENU** on the cordless handset in idle mode to enter the main menu.
2. Press ▼ or ▲ to choose **Set device** and then press **SELECT**.
3. Press ▼ or ▲ to choose **Doorbell** and then press **SELECT**.
4. Press ▼ or ▲ to choose **Dbell divert** and then press **SELECT**.
5. Press **SELECT** to select **Divert mode**.
6. Press ▼ or ▲ to choose **Decline divert** and then press **SELECT** to save.

Cancel all call divers

To cancel all call divers to the preset number:

1. Press **MENU** on the cordless handset in idle mode to enter the main menu.
2. Press ▼ or ▲ to choose **Set device** and then press **SELECT**.
3. Press ▼ or ▲ to choose **Doorbell** and then press **SELECT**.
4. Press ▼ or ▲ to choose **Dbell divert** and then press **SELECT**.
5. Press **SELECT** to select **Divert mode**.
6. Press ▼ or ▲ to choose **Off** and then press **SELECT** to save.

Test device signal strength

You can check the signal strength of your devices (**SN7014/SN7021/SN7022**, all purchased separately), for example, before mounting it. Follow the instructions below to check the signal strength between the device and the telephone base. For Extension ringer (**SN7014**) and Audio doorbell (**SN7021**), make sure you mount them in a location where the signal strength is good.

Test Extension ringer's signal strength

1. Press **MENU** on the cordless handset in idle mode to enter the main menu.
2. Press **▼** or **▲** to choose **Set device** and then press **SELECT**.
3. Press **SELECT** to select **Check signal**.
4. Scroll to select **RINGER X** (**X** represents the device number assigned to the ringer) and then press **SELECT**.
5. The handset screen displays **Awaiting signal**. Then, the telephone begins to test the signal strength.
6. When the handset screen displays **Good signal**, press **SELECT**. The testing is complete.
 - If the handset screen displays **No signal**, press **SELECT**, and then repeat from step 4 to test again.
 - If the handset screen displays **Weak signal**, press **SELECT**. Then, move the Extension ringer closer to the base, and then adjust the Extension ringer's location to improve the signal. Repeat from step 1 to test again.

Test Audio doorbell's signal strength

1. Press **MENU** on the cordless handset in idle mode to enter the main menu.
2. Press **▼** or **▲** to choose **Set device** and then press **SELECT**.
3. Press **SELECT** to select **Check signal**.
4. Scroll to select **DOORBELL X** (**X** represents the device number assigned to the ringer) and then press **SELECT**.
5. While the handset screen displays **Awaiting signal**, press the chime button on the front of the Audio doorbell.
6. When the handset screen displays **Good signal**, press **SELECT**. The testing is complete.
 - If the handset screen displays **No signal**, press **SELECT**, and then repeat from step 4 to test again.
 - If the handset screen displays **Weak signal**, press **SELECT**. Then, move the Extension ringer closer to the base, and then adjust the Extension ringer's location to improve the signal. Repeat from step 1 to test again.

Test SOS pendant's signal strength

1. Press **MENU** on the cordless handset in idle mode to enter the main menu.
2. Press **▼** or **▲** to choose **Set device** and then press **SELECT**.
3. Press **SELECT** to select **Check signal**.
4. Scroll to select **PENDANT X** (X represents the device number assigned to the ringer) and then press **SELECT**.
5. While the handset screen displays **Awaiting signal**, press **CANCEL** on the back of the SOS pendant.
6. When the handset screen displays **Good signal**, press **SELECT**. The testing is complete.
 - If the handset screen displays **No signal**, press **SELECT**, and then repeat from step 4 to test again.
 - If the handset screen displays **Weak signal**, press **SELECT**. Then, move the Extension ringer closer to the base, and then adjust the Extension ringer's location to improve the signal. Repeat from step 1 to test again.

Device monitoring

If there are additional devices registered to the telephone base, the names of the registered devices appear in the **Devices** menu of the cordless handset.

View device status

You can view the current status of each of the registered devices and check whether they are active, inactive, or with low battery.

1. Press **MENU** on the cordless handset in idle mode to enter the main menu.
2. Press **▼** or **▲** to choose **Devices** and then press **SELECT**.
3. Scroll to the desired device and then press **SELECT**.
4. Press **SELECT** to select **Status**.
 - **ACTIVE**
 - **INACTIVE**
 - **LOW BATT**

View device log

You can view the device log of each of the registered devices and check the time and event triggered on each device.

1. Press **MENU** on the cordless handset in idle mode to enter the main menu.
2. Press **▼** or **▲** to choose **Devices** and then press **SELECT**.
3. Scroll to the desired device and then press **SELECT**.
4. Press **▼** or **▲** to choose **Log**, and then press **SELECT** to view the events triggered.

Rename a device

You can rename a device.

1. Press **MENU** on the cordless handset in idle mode to enter the main menu.
2. Press ▼ or ▲ to choose **Devices** and then press **SELECT**.
3. Scroll to the desired device and then press **SELECT**.
4. Press ▼ or ▲ to choose **Rename**, and then press **SELECT** to edit the name.

Screen messages

Blocked call	An incoming call is blocked.
Block list is empty	There are no call block entries.
Caller ID log empty	There are no caller ID log entries.
Calling all devices (for telephone system with expansion handsets or devices only)	The handset is calling all devices (for intercom calls).
Calling HS X (for telephone system with expansion handsets or devices only)	The handset is calling another handset (for intercom calls). The handset is transferring an outside call to another handset.
Contact deleted	A phonebook entry is deleted.
Ended	You have just ended a call.
HANDSET X is calling (for telephone system with expansion handsets only)	Another handset is calling (for intercom calls).
Incoming call	There is an incoming call.
Intercom	The handset is on an intercom call.
Intercom ended	The intercom call has just ended.
INTERCOM TO: (for telephone system with expansion handsets or devices only)	You have started the intercom process, and need to enter the number of the handset you wish to call.

Less than 3 min	The answering system recording time is less than three minutes.
Line in use	An extension phone, or one of the handsets is in use.
Low battery	The battery needs to be recharged.
Microphone ON	The mute function is turned off and the other party can hear you.
Muted	The mute function is turned on. The other party cannot hear you but you can hear the other party.
Memory full	The answering system has no remaining recording time.
New voicemail	There are new voicemail message(s) from the telephone service provider.
No answer. Try again.	When you send out an intercom request, the destination device is in use, out of range, not powered, or does not answer within 100 seconds. When you send out a transfer request, the destination device is in use, out of range or not powered.
No line	There is no telephone line connected.
Not available at this time	Someone else is already accessing the phonebook, caller ID log or answering system.
Number already saved	The telephone number you try to save is already in the phonebook.

Out of range OR no FWR at base	The telephone base has lost power, or the handset is out of range.
Phone	The handset is on a call.
Phonebook empty	There are no phonebook entries.
Phonebook full	The phonebook is full. You cannot save any new entries unless you delete some current entries.
PRIVATE NAME	The caller is blocking the name information.
PRIVATE NUMBER	The caller is blocking the telephone number information.
PRIVATE CALLER	The caller is blocking the name and the telephone number information.
Place in charger	The battery is very low. The handset should be charged.
Rec mem full	The system recording time is full.
Rec mem low	The system recording time is low.
Registered	The handset is registered to the telephone base.
Registration failed	The registration is not successful.
Registering Please wait	The handset or pendant registration is in progress.
Ringer muted	The ringer is muted temporarily while the handset is ringing.
Ringer off	The ringer is off temporarily during an incoming call.
Saved to allow list	An entry has been added to the allow list.

Saved to block list	An entry has been added to the block list.
Saved to star name list	An entry has been added to the star name list.
Saved to Phonebook	An entry has been added to the phonebook.
Screened call	The Smart call blocker feature of the telephone has screened a call, and is putting the call through and waiting for you to pick up the call.
Setting up Answering sys...	The telephone base is playing voice guide.
Smart Call blk screening...	The telephone is screening an incoming call.
Speaker	The handset speakerphone is in use.
To register HS, see manual	Screen display on a non-registered handset.
To screen call, press [SELECT]	The system is recording a message. Press SELECT to screen a call on a handset.
Transferred	You have transferred an outside call to another system device.
UNKNOWN NAME	This caller's name is unavailable.
UNKNOWN NUMBER	This caller's number is unavailable.
UNKNOWN CALLER	No caller information is available about this caller.
XX Missed calls	There are new calls in the caller ID log.

XX New messages	There are new messages.
** Paging **	The handset is being paged by the telephone base.

General product care

Taking care of your telephone

Your telephone contains sophisticated electronic parts, so it must be treated with care.

Avoid rough treatment

Place the handset down gently. Save the original packing materials to protect your telephone if you ever need to ship it.

Avoid water

Your telephone can be damaged if it gets wet. Do not use the handset outdoors in the rain, or handle it with wet hands. Do not install the telephone base near a sink, bathtub or shower.

Electrical storms

Electrical storms can sometimes cause power surges harmful to electronic equipment. For your own safety, take caution when using electrical appliances during storms.

Cleaning your telephone

Your telephone has a durable plastic casing that should retain its luster for many years. Clean it only with a soft cloth slightly dampened with water or mild soap. Do not use excess water or cleaning solvents of any kind.

Storage

When you are not going to use the telephone for some time, unplug the adapter(s), and remove the rechargeable battery from the handset. Store the telephone base, the handset, the charger(s) and the adapter(s) in a cool and dry place.

Frequently asked questions

Below are the questions most frequently asked about the cordless telephone. If you cannot find the answer to your question, visit our website at www.vtechcanada.com or call **1 (800) 267-7377** for customer service.

My telephone does not work at all.	Make sure the telephone base is installed properly, and battery is installed and charged correctly. For optimum daily performance, return the handset to the telephone base after use, and return the pendant to the pendant charger after use.
The display shows No line. I cannot hear the dial tone.	Disconnect the telephone line cord from your telephone and connect it to another telephone. If there is no dial tone on that other telephone either, then the telephone line cord may be defective. Try installing a new telephone line cord. If changing the telephone line cord does not help, the wall jack (or the wiring to this wall jack) may be defective. Contact your telephone service provider.
	You may be using a new cable or VoIP service, the existing telephone jacks in your home may no longer work. Contact your service provider for solutions.

I cannot dial out.	Make sure there is a dial tone before dialing. It is normal if the handset takes a second or two to synchronize with the telephone base before producing a dial tone. Wait an extra second before dialing.
	Eliminate any background noise. Mute the handset before dialing, or dial from another room in your home with less background noise.
The battery does not charge in the handset or the handset battery does not accept charge.	Make sure the handset is placed in the telephone base or charger correctly.
	If the battery is completely depleted, charge the battery for at least 30 minutes before use.
	You may need to purchase a new battery.
The telephone does not ring when there is an incoming call.	Make sure the ringer volume is not set to off.
	The handset may be too far from the telephone base. Move it closer to the telephone base.
I experience poor sound quality when using the handset speakerphone.	For increased sound quality while using the handset speakerphone, place the handset on a flat surface with the dialing keys facing up.
I hear other calls when using the telephone.	Disconnect the telephone base from the telephone wall jack. Plug in a different telephone. If you still hear other calls, the problem is probably in the wiring or telephone service. Contact your telephone service provider.

There is interference during a telephone conversation. My calls fade out when I am using the cordless handset.	The handset may be out of range. Move it closer to the telephone base.
	If you subscribe to high-speed Internet service (DSL - digital subscriber line) through your telephone line, you must install a DSL filter between the telephone line cord and the telephone wall jack. The filter prevents noise and caller ID problems caused by DSL interference. Contact your DSL service provider for more information about DSL filters.
	Appliances or other cordless telephones plugged into the same circuit as the telephone base can cause interference. Try moving the appliance or telephone base to another outlet.
	The location of your telephone base can impact the performance of your cordless phone. For better reception, install the telephone base in a centralized location within your home or office, away from walls or other obstructions. In many environments, elevating the telephone base improves overall performance.

The telephone does not receive caller ID or the telephone does not show caller ID during call waiting.	Caller ID is a subscription service. You must subscribe to this service from your telephone service provider for this feature to work on your telephone.
	Both your and the caller's telephone service providers must use equipment compatible with the caller ID service.
	The caller may not be calling from an area which supports caller ID.
	The caller ID information displays after the first or second ring.
The display shows Out of range OR no pwr at base.	The handset may be out of range. Move it closer to the telephone base.
	Make sure the power cord is securely plugged into the telephone base. Use a working electrical outlet not controlled by a wall switch.
The outgoing announcement is not clear.	When recording the announcement, make sure you speak in a normal tone of voice towards the microphone of the handset.
	Make sure there is no background noise when recording.

The answering system does not answer after the correct number of rings.	Make sure that the answering system is on.
	If toll saver is activated, the number of rings changes to two when you have new messages stored.
	If the memory is full or the system is off, the system will answer after 10 rings.
	If you subscribe to voicemail service, change the number of rings so that your answering system answers before your voicemail answers. To determine how many rings activate your voicemail, contact your telephone service provider.
The answering system does not record messages.	Make sure the answering system is on. When the answering system is on, ANS ON should display on the handset.
	When the answering machine memory is full, it does not record new messages until some old messages are deleted.
	If you subscribe to voicemail service, change the number of rings so that your answering system answers before your voicemail service answers. To determine how many rings activate your voicemail service, contact your telephone service provider.
The answering system does not announce the correct day of the week for recorded messages time stamp.	Make sure you have set the date and time. See Configure your telephone section.

<p>System screens all my incoming calls.</p>	<p>You may have set Smart call blocker to screen calls without numbers and uncategorized calls. The telephone asks callers to announce their names or press the pound key (#). We recommend that you add the phone numbers of your family members and friends, and desired businesses to your Phonebook (see page 29) or Allow list (see page 35), or add their names to the Star name list (see page 37). This will avoid Smart call blocker to screen their calls.</p>
	<p>To turn Smart call blocker off, see Set Smart call blocker on/off on page 35.</p>
<p>While screening a call, the telephone suddenly stops screening and connects to the call.</p>	<p>Another handset may have picked up the screening call.</p> <p>If you have another telephone system sharing the same telephone line, and someone picks up the call on the other telephone system while the screening is in progress, the screening process will be terminated and connect you to the caller.</p>
<p>My telephone blocks calls from someone I know.</p>	<p>You may have saved the caller's number in your block list. To remove the number from the block list, see Delete a block entry on page 40.</p>
<p>Blocking calls with numbers saved in my block list only.</p>	<p>If you want to block calls with numbers saved in your block list only, and allow all other calls to get through to you, change the settings to accept calls without numbers and uncategorized calls. See Control calls without numbers on page 41 and Control uncategorized calls on page 42.</p>

<p>Blocking all unknown calls.</p>	<p>If you want to block all unknown calls with numbers that are not in your directory or allow list, change the settings to block calls without numbers and uncategorized calls. See Control calls without numbers on page 41 and Control uncategorized calls on page 42.</p>
<p>Forwarding all unknown calls to the answering system.</p>	<p>If you want to forward all unknown calls with numbers that are not in your directory or allow list to the answering system, see Control calls without numbers on page 41 and Control uncategorized calls on page 42 to change the settings.</p>
<p>The messages on the answering system are incomplete.</p>	<p>If a caller leaves a very long message, part of it may be lost when the answering system disconnects the call after the preset recording time.</p> <p>If the memory on the answering system becomes full during a message, the answering system stops recording and disconnects the call.</p> <p>If the caller's voice is very soft, the answering system may stop recording and disconnect the call.</p>

The answering system does not respond to remote commands.	Make sure you enter the correct remote access code.
	Make sure you are calling from a touch-tone telephone. When dialing a number, there should be tones. If there are clicks, then it is not a touch-tone telephone and cannot activate the answering system.
	The answering system may not detect the remote access code when your announcement is playing. Wait until the announcement is over before entering the code.
I accidentally set my LCD language to Spanish or French, and I don't know how to change it back to English.	While the handset is not in use, press MENU and then enter *364# to change the handset LCD language back to English.

The RBRC® seal

The RBRC® seal on the nickel-metal hydride battery indicates that VTech Communications, Inc. is voluntarily participating in an industry program to collect and recycle these batteries at the end of their useful lives, when taken out of service within the United States and Canada.

The RBRC® program provides a convenient alternative to placing used nickel-metal hydride batteries into the trash or municipal waste, which may be illegal in your area.

VTech's participation in RBRC® makes it easy for you to drop off the spent battery at local retailers participating in the RBRC® program or at authorized VTech product service centers. Please call **1 (800) 8 BATTERY®** for information on Ni-MH battery recycling and disposal bans/restrictions in your area. VTech's involvement in this program is part of its commitment to protecting our environment and conserving natural resources.

RBRC® and 1 (800) 8 BATTERY® are registered trademarks of Rechargeable Battery Recycling Corporation.



FCC, ACTA and IC regulations

FCC Part 15

NOTE: This equipment has been tested and found to comply with the requirements for a Class B digital device under Part 15 of the Federal Communications Commission (FCC) rules. These requirements are intended to provide reasonable protection against harmful interference in a residential installation. This equipment generates, uses and can radiate radio frequency energy and, if not installed and used in accordance with the instructions, may cause harmful interference to radio communications. However, there is no guarantee that interference will not occur in a particular installation. If this equipment does cause harmful interference to radio or television reception, which can be determined by turning the equipment off and on, the user is encouraged to try to correct the interference by one or more of the following measures:

- Reorient or relocate the receiving antenna.
- Increase the separation between the equipment and receiver.
- Connect the equipment into an outlet on a circuit different from that to which the receiver is connected.
- Consult the dealer or an experienced radio/TV technician for help.

WARNING: Changes or modifications to this equipment not expressly approved by the party responsible for compliance could void the user's authority to operate the equipment.

This device complies with Part 15 of the FCC rules. Operation is subject to the following two conditions: (1) this device may not cause harmful interference, and

(2) this device must accept any interference received, including interference that may cause undesired operation. Privacy of communications may not be ensured when using this telephone.

To ensure safety of users, the FCC has established criteria for the amount of radio frequency energy that can be safely absorbed by a user or bystander according to the intended usage of the product. This product has been tested and found to comply with the FCC criteria. The handset may be safely held against the ear of the user. The telephone base shall be installed and used such that parts of the user's body other than the hands are maintained at a distance of approximately 20 cm (8 inches) or more.

This Class B digital apparatus complies with Canadian requirement:
CAN ICES-3 (B)/NMB-3(B).

FCC Part 68 and ACTA

This equipment complies with Part 68 of the FCC rules and with technical requirements adopted by the Administrative Council for Terminal Attachments (ACTA). The label on the back or bottom of this equipment contains, among other things, a product identifier in the format US:AAAEQ##TXXXX. This identifier must be provided to your telephone service provider upon request.

The plug and jack used to connect this equipment to premises wiring and the telephone network must comply with applicable Part 68 rules and technical requirements adopted by ACTA. A compliant telephone cord and modular plug is provided with this product. It is designed to be connected to a compatible modular jack that is also compliant. An RJ11 jack should normally be used for connecting to a single line and an RJ14 jack for two lines. See the installation instructions in the user's manual.

The Ringer Equivalence Number (REN) is used to determine how many devices you may connect to your telephone line and still have them ring when you are called. The REN for this product is encoded as the 6th and 7th characters following the US: in the product identifier (e.g., if ## is 03, the REN is 0.3). In most, but not all areas, the sum of all RENs should be five (5.0) or less. For more information, please contact your telephone service provider.

This equipment must not be used with Party Lines. If you have specially wired alarm dialing equipment connected to your telephone line, ensure the connection of this equipment does not disable your alarm equipment. If you have questions about what will disable alarm equipment, consult your telephone service provider or a qualified installer.

If this equipment is malfunctioning, it must be unplugged from the modular jack until the problem has been corrected. Repairs to this telephone equipment can only be made by the manufacturer or its authorized agents. For repair procedures, follow the instructions outlined under the **Limited warranty**.

If this equipment is causing harm to the telephone network, the telephone service provider may temporarily discontinue your telephone service. The telephone service provider is required to notify you before interrupting service. If advance notice is not practical, you will be notified as soon as possible. You will be given the opportunity to correct the problem and the telephone service provider is required to inform you of your right to file a complaint with the FCC. Your telephone service provider may make changes in its facilities, equipment, operation, or procedures that could affect the proper functioning of this product. The telephone service provider is required to notify you if such changes are planned.

If this product is equipped with a corded or cordless handset, it is hearing aid compatible.

If this product has memory dialing locations, you may choose to store emergency telephone numbers (e.g., police, fire, medical) in these locations. If you do store or test emergency numbers, please:

Remain on the line and briefly explain the reason for the call before hanging up.

Perform such activities in off-peak hours, such as early morning or late evening.

Industry Canada

This device contains licence-exempt transmitter(s)/receiver(s) that comply with Innovation, Science and Economic Development Canada's licence-exempt RSS(s). Operation is subject to the following two conditions:

- (1) This device may not cause interference.
- (2) This device must accept any interference, including interference that may cause undesired operation of the device.

Privacy of communications may not be ensured when using this telephone.

The term "IC:" before the certification/registration number only signifies that the Industry Canada technical specifications were met.

The Ringer Equivalence Number (REN) for this terminal equipment is 1.0. The REN indicates the maximum number of devices allowed to be connected to a telephone interface. The termination of an interface may consist of any combination of devices subject only to the requirement that the sum of the RENs of all the devices not exceed five.

This product meets the applicable Innovation, Science and Economic Development Canada technical specifications.

Limited warranty

What does this limited warranty cover?

The manufacturer of this VTech Product warrants to the holder of a valid proof of purchase ("Consumer" or "you") that the Product and all accessories provided in the sales package ("Product") are free from defects in material and workmanship, pursuant to the following terms and conditions, when installed and used normally and in accordance with the Product operating instructions. This limited warranty extends only to the Consumer for Products purchased and used in the United States of America and Canada.

What will VTech do if the Product is not free from defects in materials and workmanship during the limited warranty period ("Materially Defective Product")?

During the limited warranty period, VTech's authorized service representative will repair or replace at VTech's option, without charge, a Materially Defective Product. If we repair the Product, we may use new or refurbished replacement parts. If we choose to replace the Product, we may replace it with a new or refurbished Product of the same or similar design. We will retain defective parts, modules, or equipment. Repair or replacement of the Product, at VTech's option, is your exclusive remedy. VTech will return the repaired or replacement Products to you in working condition. You should expect the repair or replacement to take approximately 30 days.

How long is the limited warranty period?

The limited warranty period for the Product extends for ONE (1) YEAR from the date of purchase. If VTech repairs or replaces a Materially Defective Product under the terms of this limited warranty, this limited warranty also applies to the repaired or replacement Product for a period of either (a) 90 days from the date the repaired or replacement Product is shipped to you or (b) the time remaining on the original one-year warranty; whichever is longer.

What is not covered by this limited warranty?

This limited warranty does not cover:

1. Product that has been subjected to misuse, accident, shipping or other physical damage, improper installation, abnormal operation or handling, neglect, inundation, fire, water or other liquid intrusion;
2. Product that has been damaged due to repair, alteration or modification by anyone other than an authorized service representative of VTech;
3. Product to the extent that the problem experienced is caused by signal conditions, network reliability, or cable or antenna systems;
4. Product to the extent that the problem is caused by use with non-VTech accessories;
5. Product whose warranty/quality stickers, product serial number plates or electronic serial numbers have been removed, altered or rendered illegible;
6. Product purchased, used, serviced, or shipped for repair from outside the United States of America or Canada, or used for commercial or institutional purposes (including but not limited to Products used for rental purposes);

7. Product returned without a valid proof of purchase (see item 2 below); or
8. Charges for installation or set up, adjustment of customer controls, and installation or repair of systems outside the unit.

How do you get warranty service?

To obtain warranty service, please visit our website at www.vtechcanada.com or call 1 (800) 267-7377.

NOTE: Before calling for service, please review the user's manual - a check of the Product's controls and features may save you a service call.

Except as provided by applicable law, you assume the risk of loss or damage during transit and transportation and are responsible for delivery or handling charges incurred in the transport of the Product(s) to the service location. VTech will return repaired or replaced Product under this limited warranty. Transportation, delivery or handling charges are prepaid. VTech assumes no risk for damage or loss of the Product in transit. If the Product failure is not covered by this limited warranty, or proof of purchase does not meet the terms of this limited warranty, VTech will notify you and will request that you authorize the cost of repair prior to any further repair activity. You must pay for the cost of repair and return shipping costs for the repair of Products that are not covered by this limited warranty.

What must you return with the Product to get warranty service?

1. Return the entire original package and contents including the Product to the VTech service location along with a description of the malfunction or difficulty; and
2. Include a "valid proof of purchase" (sales receipt) identifying the Product purchased (Product model) and the date of purchase or receipt; and

- Provide your name, complete and correct mailing address, and telephone number.

Other limitations

This warranty is the complete and exclusive agreement between you and VTech. It supersedes all other written or oral communications related to this Product. VTech provides no other warranties for this Product. The warranty exclusively describes all of VTech's responsibilities regarding the Product. There are no other express warranties. No one is authorized to make modifications to this limited warranty and you should not rely on any such modification.

State/Provincial Law Rights: This warranty gives you specific legal rights, and you may also have other rights, which vary from state to state or province to province.

Limitations: Implied warranties, including those of fitness for a particular purpose and merchantability (an unwritten warranty that the Product is fit for ordinary use) are limited to one year from the date of purchase. Some states/provinces do not allow limitations on how long an implied warranty lasts, so the above limitation may not apply to you. In no event shall VTech be liable for any indirect, special, incidental, consequential, or similar damages (including, but not limited to lost profits or revenue, inability to use the Product or other associated equipment, the cost of substitute equipment, and claims by third parties) resulting from the use of this Product. Some states/provinces do not allow the exclusion or limitation of incidental or consequential damages, so the above limitation or exclusion may not apply to you.

Please retain your original sales receipt as proof of purchase.

Technical specifications

Frequency control	Crystal controlled PLL synthesizer
Transmit frequency	Handset: 1921.536-1928.448 MHz Telephone base: 1921.536-1928.448 MHz
Channels	5
Nominal effective range	Maximum power allowed by FCC and IC. Actual operating range may vary according to environmental conditions at the time of use.
Power requirements	Handset: 1.2V 500mAh, 3 x AAA Ni-MH battery Telephone base: 6V DC @ 800mA Charger: 6V DC @ 400mA
Memory	Phonebook: 50 memory locations; up to 30 digits and 15 characters Caller ID log: 50 memory locations; up to 24 digits and 15 characters Call block: 1000 entries



Designed to fit your home.
And your life.

VTech Technologies Canada Ltd.
A member of THE VTECH GROUP OF COMPANIES.
VTech is a registered trademark of VTech Holdings Limited.
Specifications are subject to change without notice.
© 2018 VTech Technologies Canada Ltd.
All rights reserved. 10/18. SN5147_CA_WEBICIB_V1.0
Document order number: 91-011565-010-100

